



Parameter	Rating	Units
Blocking Voltage	350	V_P
Load Current	100	mA_{rms} / mA_{DC}
On-Resistance (max)	50	Ω

Features

- 3750V_{rms} Input/Output Isolation
- Low Drive Power Requirements
- FCC Compatible
- VDE Compatible
- High Reliability
- Arc-Free With No Snubbing Circuits
- No EMI/RFI Generation
- Small 8-Pin Package
- Surface Mount Tape & Reel Version Available
- Flammability Rating UL 94 V-0

Applications

- Telecommunications
 - Telecom Switching
 - Tip/Ring Circuits
 - Modem Switching (Laptop, Notebook, Pocket Size)
 - Hook Switch
 - Dial Pulsing
 - Ground Start
 - Ringing Injection
- Instrumentation
- Multiplexers
- Data Acquisition
- Electronic Switching
- I/O Subsystems
- Meters (Watt-Hour, Water, Gas)
- Medical Equipment-Patient/Equipment Isolation
- Security
- Aerospace
- Industrial Controls

Description

The XS170 integrated circuit device combines a 350V, 100mA, 50 Ω , normally open (1-Form-A) relay with an optocoupler in a single package. The relay uses optically coupled MOSFET technology to provide 3750V_{rms} of input to output isolation.

Its optically coupled outputs, which use the patented OptoMOS architecture, are controlled by a highly efficient infrared LED.

Telecom circuit designers, using the XS170, can now take advantage of two discrete functions in a single component that uses less space than traditional discrete component solutions.

Approvals

- UL Recognized Component: File E76270
- EN/IEC 60950-1 Certified Component:
TUV Certificate: B 13 12 82667 003

Ordering Information

Part #	Description
XS170	8-Pin DIP (50/Tube)
XS170S	8-Pin Surface Mount (50/Tube)
XS170STR	8-Pin Surface Mount (1000/Reel)

Pin Configuration

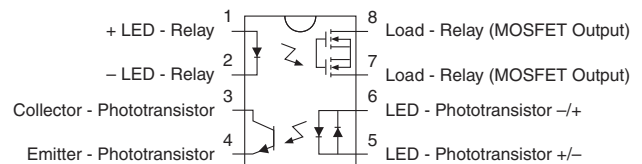

Switching Characteristics of Normally Open Devices

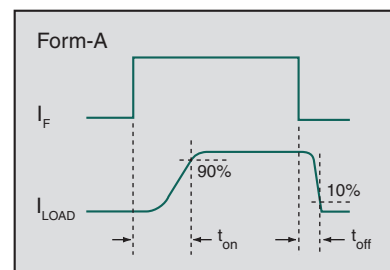

Absolute Maximum Ratings @ 25°C

Parameter	Ratings	Units
Relay Blocking Voltage	350	V _P
Reverse Input Voltage	5	V
Input Power Dissipation ¹	150	mW
Relay Input Control Current	50	mA
Peak (10ms)	1	A
Detector Input Control Current	100	mA
Total Power Dissipation ²	800	mW
Isolation Voltage, Input to Output	3750	V _{rms}
Operational Temperature (T _A)	-40 to +85	°C
Storage Temperature	-40 to +125	°C

¹ Derate linearly 1.33 mW / °C

² Derate linearly 6.67 mW / °C

Absolute Maximum Ratings are stress ratings. Stresses in excess of these ratings can cause permanent damage to the device. Functional operation of the device at conditions beyond those indicated in the operational sections of this data sheet is not implied.

Typical values are characteristic of the device at +25°C, and are the result of engineering evaluations. They are provided for information purposes only, and are not part of the manufacturing testing requirements.

Electrical Characteristics @25°C: Relay Section

Parameter	Conditions	Symbol	Min	Typ	Max	Units
Output Characteristics						
Load Current, Continuous						
Continuous	-	I _L	-	-	100	mA _{rms} / mA _{DC}
Peak	t=10ms	I _{LPK}	-	-	±350	mA _P
On-Resistance	I _L =120mA	R _{ON}	-	33	50	Ω
Off-State Leakage Current	V _L =350V	I _{LEAK}	-	-	1	μA
Switching Speeds						
Turn-On	I _F =5mA, V _L =10V	t _{on}	-	-	5	ms
Turn-Off		t _{off}	-	-	5	
Output Capacitance	I _F =0mA, V _L =50V, f=1MHz	C _{OUT}	-	25	-	pF
Input Characteristics						
Input Control Current to Activate	I _L =120mA	I _F	-	-	2	mA
Input Control Current to Deactivate	-	I _F	0.4	0.7	-	mA
Input Voltage Drop	I _F =5mA	V _F	0.9	1.2	1.4	V
Reverse Input Current	V _R =5V	I _R	-	-	10	μA
Common Characteristics						
Capacitance, Input to Output	V _{IO} =0V, f=1MHz	C _{IO}	-	3	-	pF

Electrical Characteristics @25°C: Detector Section

Parameter	Conditions	Symbol	Min	Typ	Max	Units
Output Characteristics						
Phototransistor Blocking Voltage	I _C =10μA	BV _{CEO}	20	50	-	V
Phototransistor Dark Current	V _{CE} =5V, I _F =0mA	I _{CEO}	-	50	500	nA
Saturation Voltage	I _C =2mA, I _F =16mA	V _{SAT}	-	0.3	0.5	V
Current Transfer Ratio	I _F =6mA, V _{CE} =0.5V	CTR	33	100	-	%
Input Characteristics						
Input Control Current	I _C =2mA, V _{CE} =0.5V	I _F	-	2	6	mA
Input Voltage Drop	I _F =5mA	V _F	0.9	1.2	1.4	V
Input Current (Detector must be off)	I _C =1μA, V _{CE} =5V	I _F	5	25	-	μA
Isolation, Input to Output	-	V _{IO}	3750	-	-	V _{rms}
Common Characteristics						
Input to Output Capacitance	-	C _{IO}	-	3	-	pF

RELAY PERFORMANCE DATA *

Typical LED Forward Voltage Drop
(N=50, $I_F=5\text{mA}$)

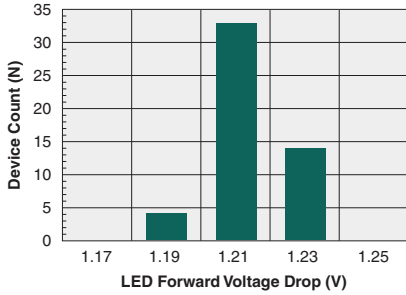

Typical I_F for Switch Operation
(N=50, $I_L=100\text{mA}_{DC}$)

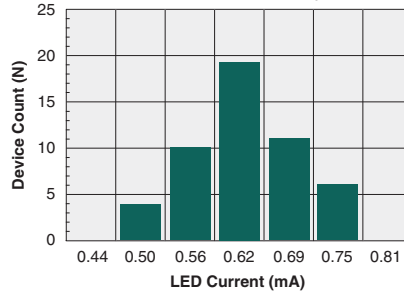

Typical I_F for Switch Dropout
(N=50, $I_L=100\text{mA}_{DC}$)

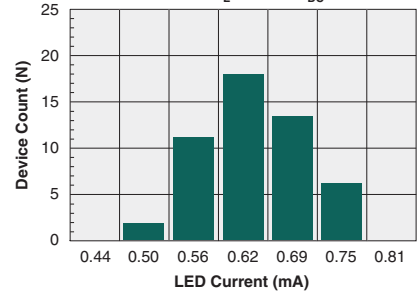

Typical On-Resistance Distribution
(N=50, $I_L=100\text{mA}_{DC}$)

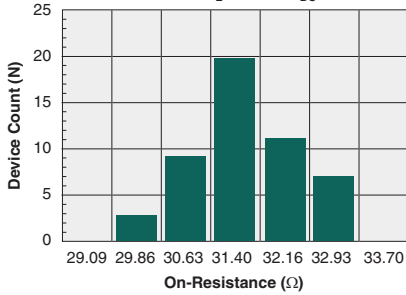

Typical Turn-On Time
(N=50, $I_L=100\text{mA}_{DC}$)

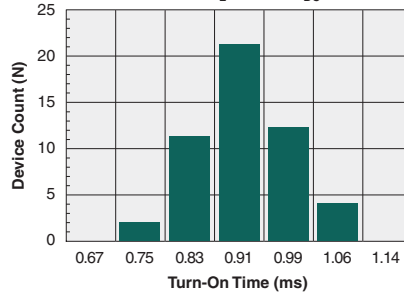

Typical Turn-Off Time
(N=50, $I_L=100\text{mA}_{DC}$)

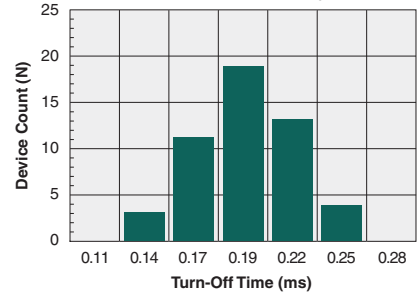

Typical Blocking Voltage Distribution
(N=50)

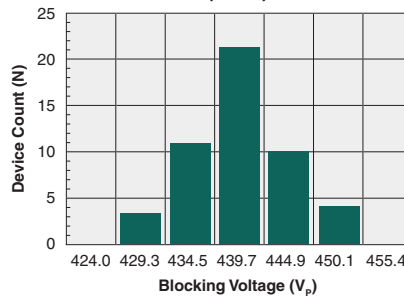

Typical LED Forward Voltage Drop vs. Temperature

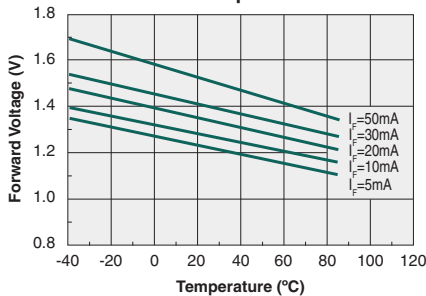

Typical I_F for Switch Operation vs. Temperature
($I_L=100\text{mA}_{DC}$)

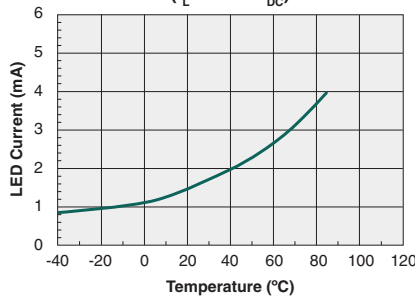

Typical I_F for Switch Dropout vs. Temperature
($I_L=100\text{mA}_{DC}$)

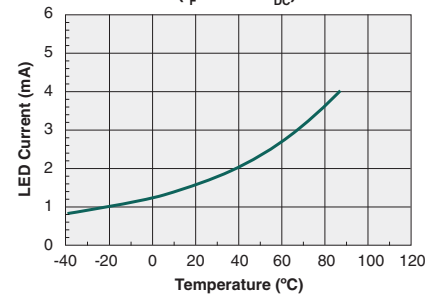

* Unless otherwise noted, data presented in these graphs is typical of device operation at 25°C.
For guaranteed parameters not indicated in the written specifications, please contact our application department.

RELAY PERFORMANCE DATA*

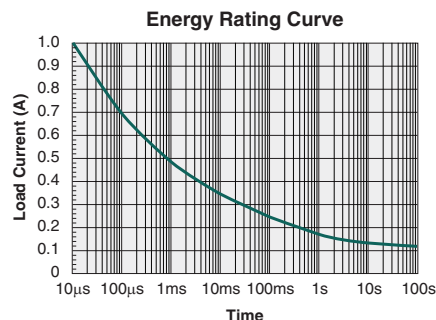
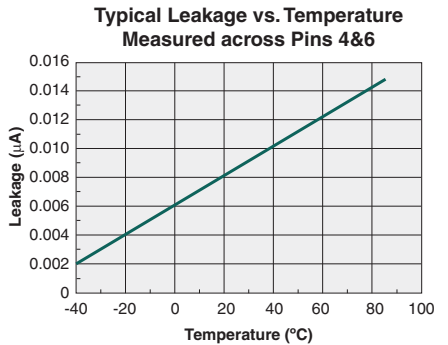
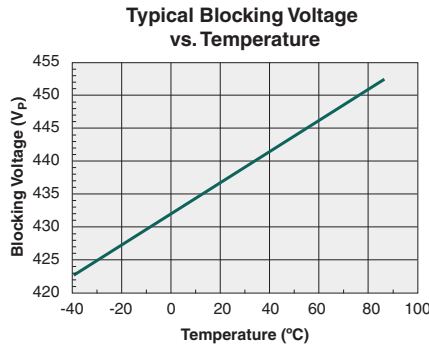
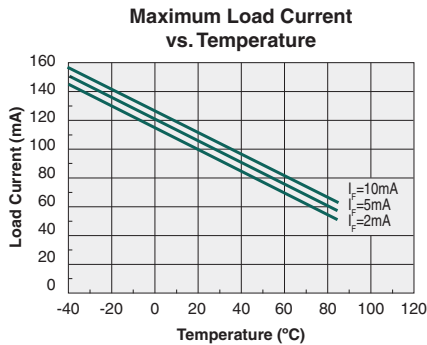
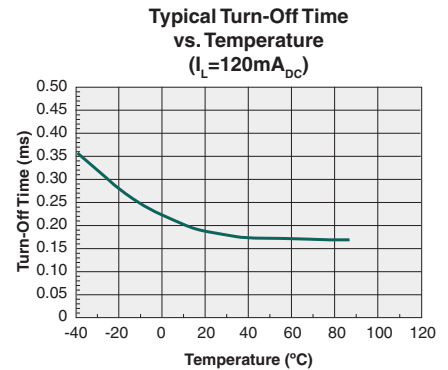
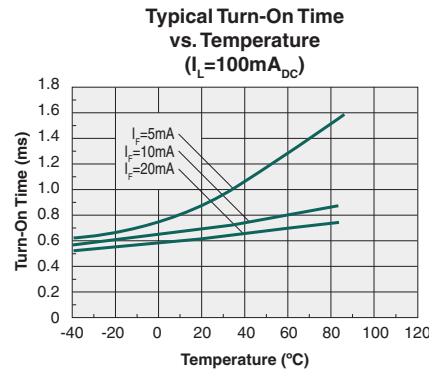
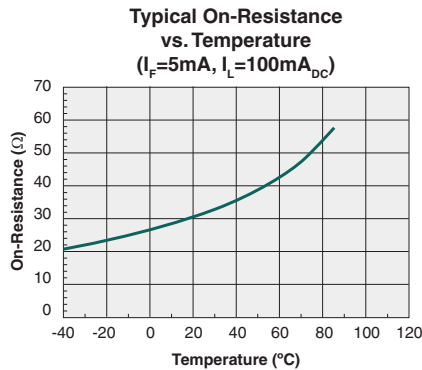
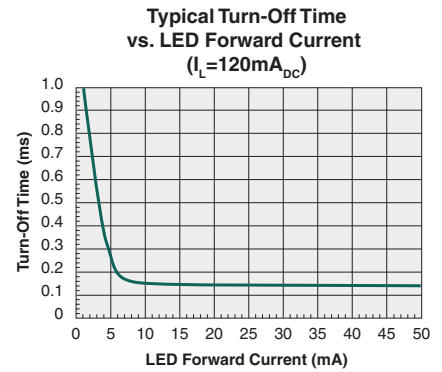
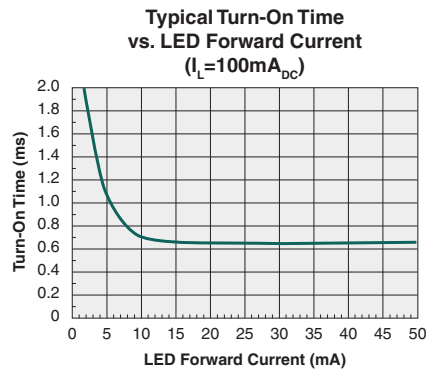
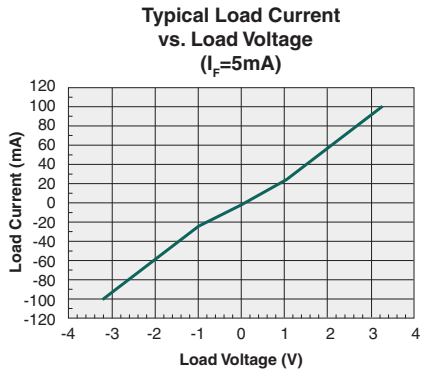

* Unless otherwise noted, data presented in these graphs is typical of device operation at 25°C. For guaranteed parameters not indicated in the written specifications, please contact our application department.

DETECTOR PERFORMANCE DATA*

Typical Normalized CTR vs. Forward Current
 ($V_{CE}=0.5V$)

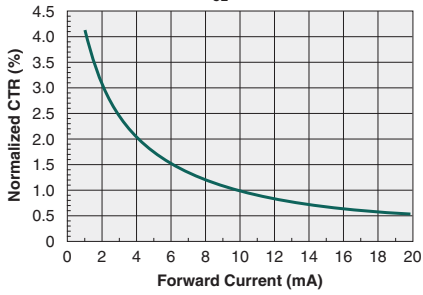

Typical Normalized CTR vs. Temperature
 ($V_{CE}=0.5V$)

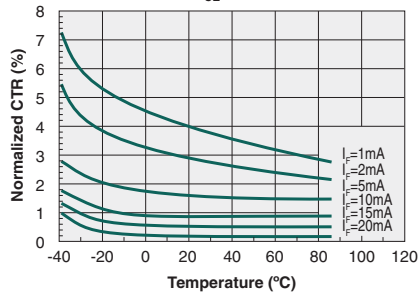

Typical Collector Current vs. Forward Current
 ($V_{CE}=0.5V$)

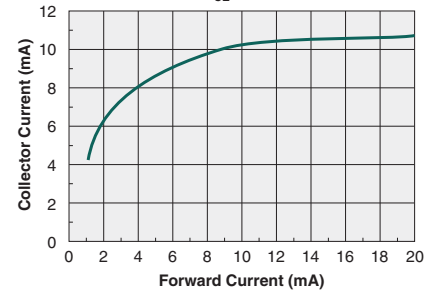

* Unless otherwise noted, data presented in these graphs is typical of device operation at 25°C.
 For guaranteed parameters not indicated in the written specifications, please contact our application department.

Manufacturing Information

Moisture Sensitivity



All plastic encapsulated semiconductor packages are susceptible to moisture ingress. IXYS Integrated Circuits Division classifies its plastic encapsulated devices for moisture sensitivity according to the latest version of the joint industry standard, **IPC/JEDEC J-STD-020**, in force at the time of product evaluation. We test all of our products to the maximum conditions set forth in the standard, and guarantee proper operation of our devices when handled according to the limitations and information in that standard as well as to any limitations set forth in the information or standards referenced below.

Failure to adhere to the warnings or limitations as established by the listed specifications could result in reduced product performance, reduction of operable life, and/or reduction of overall reliability.

This product carries a Moisture Sensitivity Level (MSL) classification as shown below, and should be handled according to the requirements of the latest version of the joint industry standard **IPC/JEDEC J-STD-033**.

Device	Moisture Sensitivity Level (MSL) Classification
XS170 / XS170S	MSL 1

ESD Sensitivity



This product is **ESD Sensitive**, and should be handled according to the industry standard **JESD-625**.

Soldering Profile

Provided in the table below is the Classification Temperature (T_c) of this product and the maximum dwell time the body temperature of this device may be ($T_c - 5$)°C or greater. The classification temperature sets the Maximum Body Temperature allowed for this device during lead-free reflow processes. For through-hole devices, and any other processes, the guidelines of **J-STD-020** must be observed.

Device	Classification Temperature (T_c)	Dwell Time (t_p)	Max Reflow Cycles
XS170	250°C	30 seconds	-
XS170S	250°C	30 seconds	3

Board Wash

IXYS Integrated Circuits Division recommends the use of no-clean flux formulations. Board washing to reduce or remove flux residue following the solder reflow process is acceptable provided proper precautions are taken to prevent damage to the device. These precautions include, but are not limited to: using a low pressure wash and providing a follow up bake cycle sufficient to remove any moisture trapped within the device due to the washing process. Due to the variability of the wash parameters used to clean the board, determination of the bake temperature and duration necessary to remove the moisture trapped within the package is the responsibility of the user (assembler). Cleaning or drying methods that employ ultrasonic energy may damage the device and should not be used. Additionally, the device must not be exposed to flux or solvents that are Chlorine- or Fluorine-based.



Mechanical Dimensions

XS170

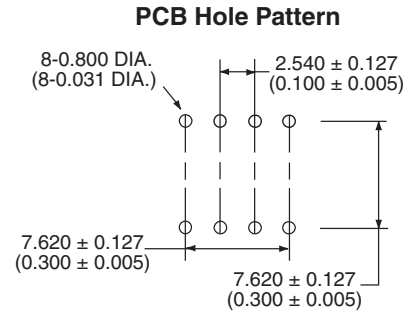
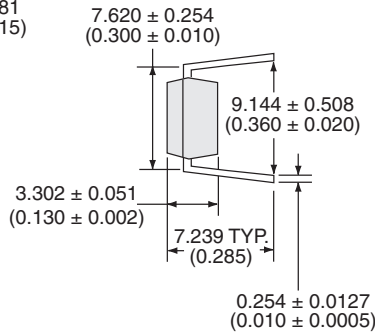
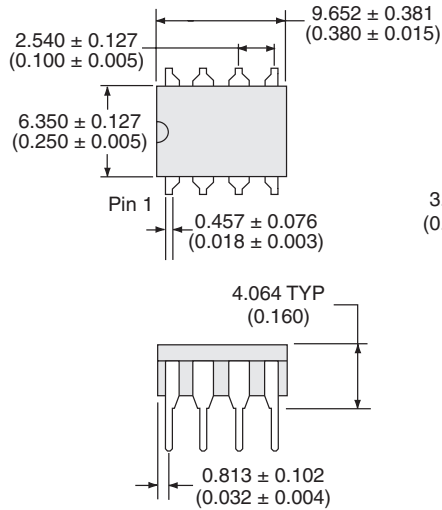

Dimensions
mm
(inches)

XS170S

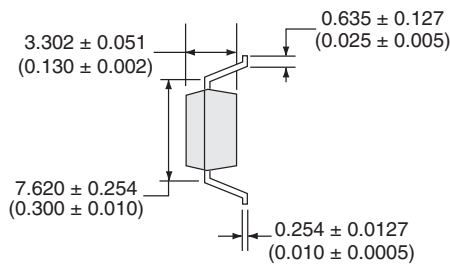
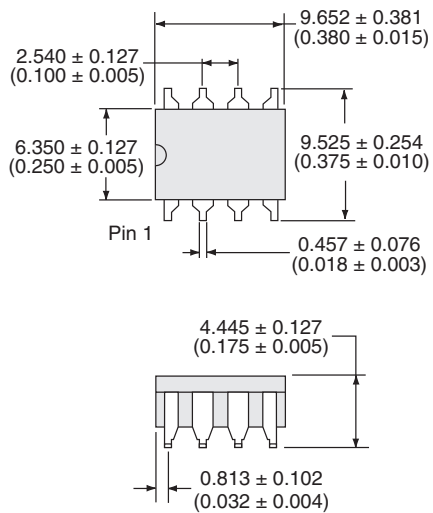

PCB Land Pattern

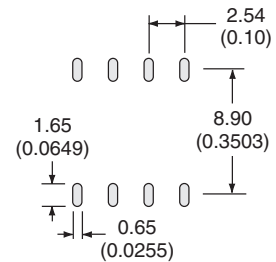

Dimensions
mm
(inches)

XS170STR Tape & Reel

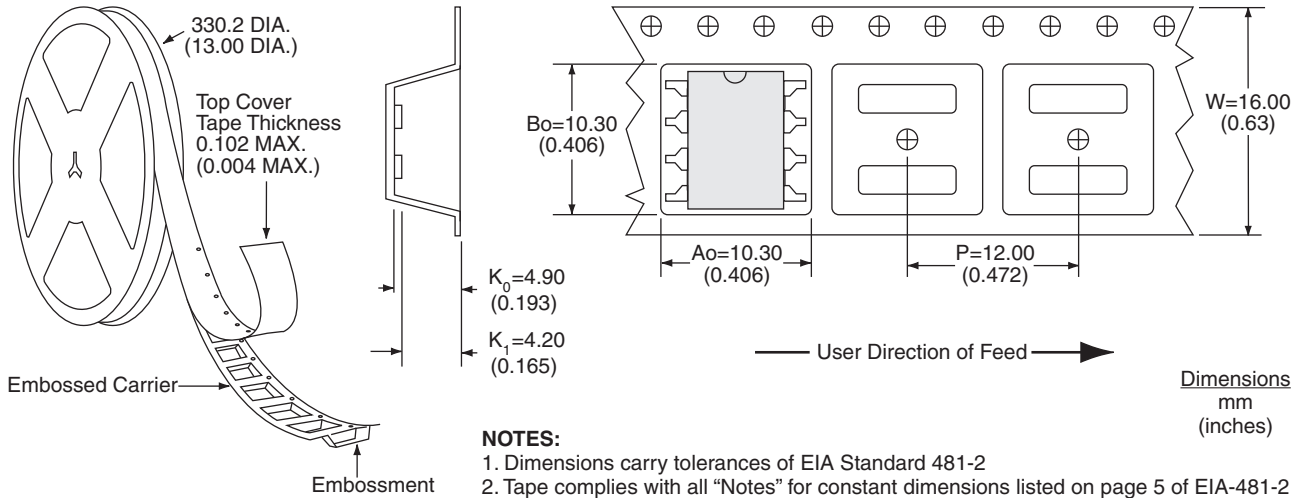

For additional information please visit our website at: www.ixysic.com

IXYS Integrated Circuits Division makes no representations or warranties with respect to the accuracy or completeness of the contents of this publication and reserves the right to make changes to specifications and product descriptions at any time without notice. Neither circuit patent licenses nor indemnity are expressed or implied. Except as set forth in IXYS Integrated Circuits Division's Standard Terms and Conditions of Sale, IXYS Integrated Circuits Division assumes no liability whatsoever, and disclaims any express or implied warranty, relating to its products including, but not limited to, the implied warranty of merchantability, fitness for a particular purpose, or infringement of any intellectual property right.

The products described in this document are not designed, intended, authorized or warranted for use as components in systems intended for surgical implant into the body, or in other applications intended to support or sustain life, or where malfunction of IXYS Integrated Circuits Division's product may result in direct physical harm, injury, or death to a person or severe property or environmental damage. IXYS Integrated Circuits Division reserves the right to discontinue or make changes to its products at any time without notice.

Mouser Electronics

Authorized Distributor

Click to View Pricing, Inventory, Delivery & Lifecycle Information:

[IXYS:](#)

[XS170S](#) [XS170STR](#) [XS170](#) [XS170P](#) [XS170PTR](#)