

MICROFLAT SERIES

TYPES “FR” AND “PR”

AUTOMATIC CONTROL SYSTEMS FOR GAS BURNERS AND INSTALLATIONS WITH OR WITHOUT FAN

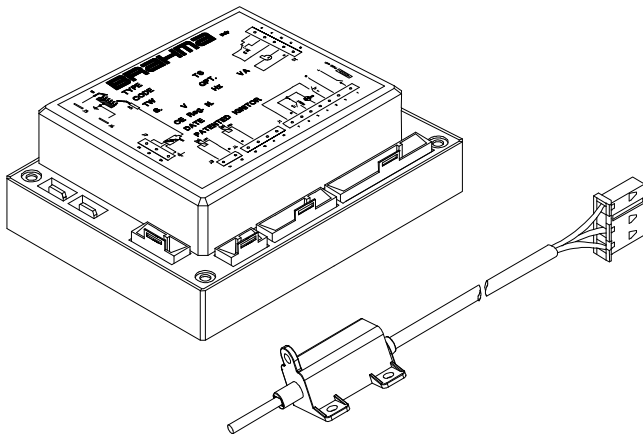

MICROFLAT TYPE “FR”

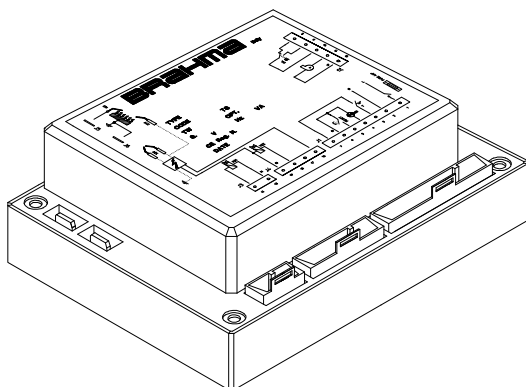

MICROFLAT TYPE “PR”

APPLICATION

This range of electronic gas burner control systems has been specifically designed for atmospheric gas burners for intermittent operation (systems for non-permanent operation), with or without fan in the combustion circuit. Types CM..FR(PR), MM..FR and SM.1FR are provided with non-volatile lockout, i.e. the restart from the safety shutdown condition can only be accomplished by a manual reset of the system.

Types CE..FR (PR), ME..FR and SE..FR are provided with volatile lockout, i.e. a restart from the lockout condition can be accomplished by an interruption of the mains power supply and its subsequent restoration.

The automatic burner control units of this series are suitable for:

- combi boilers (only non-volatile lockout types);
- heating boilers (only non-volatile lockout types);
- warm air generators;
- radiant heaters;
- water heaters.

The MICROFLAT controllers type “FR” are able to operate while fitted only to the BRAHMA ignition transformer model TR2

The MICROFLAT controllers type “PR” are equipped with a connector for the connection of an external ignition device (chosen by the user). Therefore the controllers can be used in all the applications where ignition difficulties occur, and so the use of pilot valve and hot surface igniters can be avoided. In order to reduce the EMC emitted from the ignition devices, these controllers can be fitted to our electronic transformers type TC1AF-TC2AF with an EMC filter-suppressor (see the technical sheet of “Electronic ignition transformers”).

Thanks to their design and variety of models, they can also be used for the automation of furnaces, cookers, stoves and in gas firing installations with atmospheric burner in general.

FEATURES

TABLE 1 shows the main features of this series. Other important features are:

- **EC**-type certification (CE Reg. No. 0063AT1990) in compliance with the Gas Directive 90/396/EEC and following amendments, Directive 93/68/EEC related to the electrical reset and manual reset versions in compliance with EN 298:1993 standard (Devices distributable exclusively as spare parts);
- **EC**-type certification (CE Reg. No. 0694BP0699) in compliance with Gas Directive 90/396/EEC and following amendments, Directive 93/68/EEC related to manual reset versions in compliance with EN 298:2003;
- Two independent safety contacts in series on the gas valve/s output (manual reset versions);
- Possibility to have an auxiliary contact for low power ignition or main gas valve control for intermittent pilot systems (this contact is not isolated from the main supply voltage by reinforced isolation, therefore the contact is not suitable to control SELV circuits– Safety Extra Low Voltage, e.g. 24V);

- possibility of mounting a resistor ($0 \div 220 \Omega$) in series to the valve outputs, in case the valves operate with direct current obtained through the rectification of the supply alternate current by means of one or more diodes. This resistor allows to reduce electromagnetic disturbances generated by diodes switching;
- for non-volatile lockout versions, possibility of mounting a resistor ($0 \div 470 \text{ k}\Omega$) in series to the lockout signal output, to avoid possible damages to the control in case the connections of the reset push-button and the connections of the lockout signal are reversed;
- flame monitoring by the rectification property of the flame (ionization).
- "FR" types: high efficiency remote ignition device (model. TR2: for technical features see technical sheet "REMOTE IGNITION TRANSFORMERS TR2") with an EMC filter-suppressor inside the device;
- "PR" types: command output for ignition devices with line voltage .

TABLE N°1

	Single flame	Dual flame	Atmospheric without fan	Atmospheric with fan	Monoelectrode	Non-volatile lockout	Volatile lockout	Auxiliary contact (1)	Connectors type molex (2)	According to EN 298:1993 (3)	According to EN 298:2003 (4)	Classification code according to EN298 (5)
CM11FR	•		•			•			•	•	•	AMCLXN
CM12FR		•	•			•			•	•	•	ATCLXN
CM31FR	•			•		•			•	•	•	FMCLXN
CM32FR		•		•		•			•	•	•	FTCLXN
SM11FR	•		•			•		•	•	•	•	ATCLXN
MM11FR	•		•		•	•			•	•	•	AMCLXN
MM12FR		•	•		•	•			•	•	•	ATCLXN
MM31FR	•			•	•	•			•	•	•	FMCLXN
MM32FR		•		•	•	•			•	•	•	FTCLXN
CE11FR	•		•			•			•	•		AMCVXN
CE31FR	•			•		•			•	•		FMCVXN
ME11FR	•		•		•	•			•	•		AMCVXN
CM32PR		•		•		•			•	•	•	FTCLXN
CE32PR		•		•		•			•	•		FTCVXN

- (1) This contact is not isolated from the main supply voltage by reinforced isolation, therefore the relay contact is not suitable to supply SELV circuits – Safety Extra Low Voltage.
- (2) Standard connectors are Stelvio/Stocko models, see Fig.2.
- (3) The controllers in compliance with EN298:1993 can be employed exclusively as spare parts.
- (4) The controller shows on the label option "#" and the note "EN 298:2003 compliant".
- (5) Flame failure during TS causes spark restoration.

TECHNICAL DATA

Supply Voltage:	220-240 V ~ 50-60 Hz
on request:	110-120 V ~ 50-60 Hz
Operating temperature range:	-20 °C ÷ +60 °C
Ambient humidity:	95% max. @ +40 °C
Protection degree:	IP 00

Times:

- Prepurge or waiting time (TW/TP):	1,5 ... 40 s
- Safety time (TS):	3 ... 120 s
- Drop out time on running flame failure:	< 1 s

The times given on the burner control label correspond to the values guaranteed. The actual values differ slightly from the values given, as prepurge or waiting time can be longer and safety time shorter than their nominal values.

Starting power consumption:

types WITHOUT burner:	10 VA
types WITH burner:	12 VA

Operating power consumption:

types WITHOUT burner:	7 VA
types WITH burner:	9 VA

Contact rating:

Thermostat:	4.0 A $\cos \varphi \geq 0.4$
VG1:	0.5 A $\cos \varphi \geq 0.4$
VG2:	0.5 A $\cos \varphi \geq 0.4$
Fan:	1.0 A $\cos \varphi \geq 0.4$
Ignition device (PR version):	1.0 A $\cos \varphi \geq 0.4$
Alarm:	1.0 A $\cos \varphi = 1.0$
Auxiliary contact:	0.5 A $\cos \varphi \geq 0.4$

Max length of the cables of external components:

1 m

Internal fuse rating:

4A quick acting

External fuse rating:

3.15A quick acting

Flame control:

The ionization flame detection device makes use of the rectification property of the flame.

This device is not provided with any protective impedance, therefore the detection electrode is not safe against the risk of electric shock.

Minimum ionization current: 0.5 μ A

on request: 1.2 μ A / 2.5 μ A

Recommended ionization current: 3 ÷ 5 volte la min.

Max. length of the cable: 1 m

Minimum insulation resistance of the flame detection device to earth: $\geq 50 \text{ M}\Omega$

Max. stray capacitance of the detection probe $\leq 1 \text{ nF}$

Max. short circuit current: < 200 μ A AC

Weight:

Types "PR": 155 g

Types "FR": 165 g

CONSTRUCTION

The enclosure made of plastic material and the varnishing of printed circuit boards protect the control from possible damages resulting from crashes, incautious opening, dust and contact with the external environment.

Through the use of a printed circuit board assembled with surface mounted components and of a new **patented** circuit generating the ignition spark which reduces the electromagnetic interference to a minimum (types FR), it has been possible to reduce the printed circuit board dimensions and to realize even the most complex executions with extremely compact dimensions.

A varistor protects the control from possible voltage transients on the electric network, caused for example by discharges such as thunderbolts. An inbuilt fuse protects the relays of the control box in case of short circuit on the outputs (valves, fan and lockout signal).

OVERALL DIMENSIONS

The control units of the MICROFLAT series can be supplied in different executions but with the same enclosure. The following figures show the overall dimensions of the controls (Fig.1).

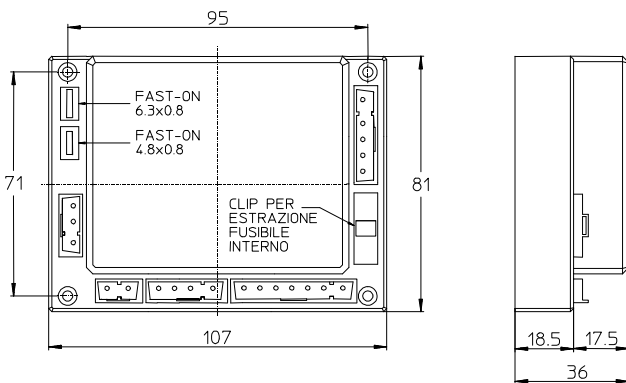

Fig.1 – Overall dimensions

POSSIBLE FIXING SYSTEMS

Top:

- self-tapping screw UNI 6951 AB 2,9x22
- M3x22 screw UNI6107

Bottom:

- screwplast self-forming screw ISO0003 F 3.5x13
- screwplast self-forming screw ISO0003 F 3.9x13

ACCESSORIES

The control units can be supplied complete with connectors and light reset push-button (see Fig.2 and Fig.3).

In any case do not fit terminals and female connectors of different types.

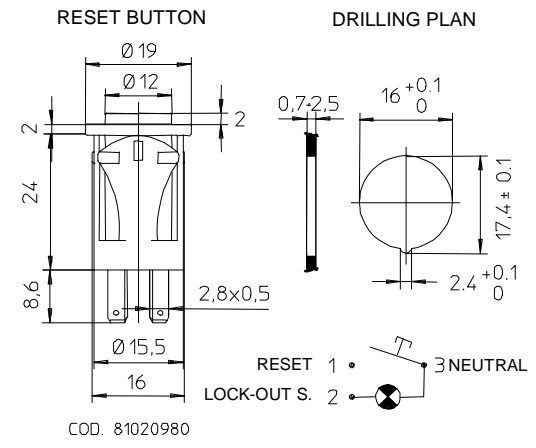

Fig.2

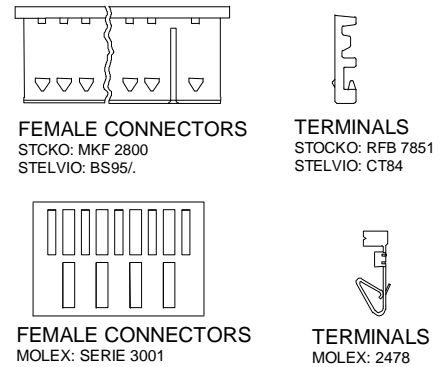

Fig.3

CONNECTION

The use of non-reversible connectors with a different number of poles makes the connection easy and reliable. One-way fast-on connectors of different sizes for detection electrodes and earth connection enable an easy installation and replacement.

The single output controllers of the MICROFLAT series type "PR" allow the spark generation only on one point (4a), while the dual output controller allows the spark generation on two points (4b) or between two electrodes isolated from the metal frame of the burner (4c); this last configuration ensures a limited EMC emission.

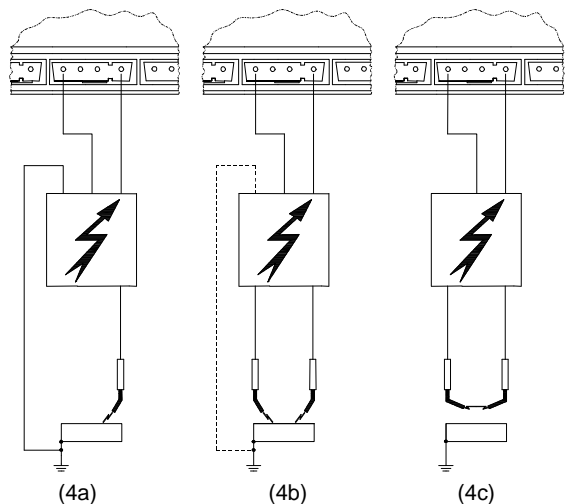

Fig.4

The controllers of the MICROFLAT series type “FR” allow the spark generation only on one point, as shown in Fig.5.

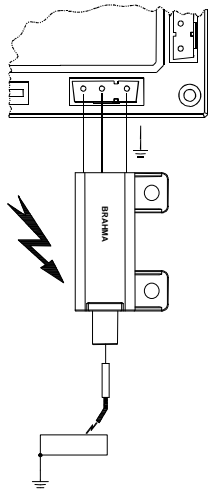

Fig.5

Provisions such as strain relieves, sufficient earth terminals and neutral terminals have to be available in the appliance or in external connection boxes.

DIRECTIONS FOR USE

- Automatic controls are safety devices and must not be opened. The manufacturer’s responsibility and guarantee are invalidated if the control is incautiously opened.
- For technical safety reasons a regulation shutdown must occur every 24 hours (systems for non-permanent operation).
- The control can be connected and disconnected only after switching off the power supply.
- The control can be mounted in any position.
- Avoid exposing the control unit to dripping water.
- Ventilation and the lowest temperature ensure the longest life of the control.
- Make sure that the type (part number and times) you are using is correct before installing or replacing the control.
- The gas appliance in which the control is installed must provide adequate protection against the risk of electric shock (at least IP20).

ELECTRICAL INSTALLATION

- The applicable national and European standards (e.g. EN 60335-1/EN 50165) regarding electrical safety must be respected.
- Live and neutral must be connected correctly, a mistake could cause a dangerous situation, i.e. the internal and external protection and safety devices can be ineffective in case the cables connecting thermostats and valves should lose their isolation. If live-neutral polarity is not respected the control performs a lockout at the end of safety time.
- Before starting the system check the cables carefully. Wrong connections can damage the control and compromise the safety of the installation.

- The earth terminal of the control, the metal frame of the burner and the earth of the electric system must be well connected.
- Avoid putting the detection cable close to power or ignition cables.
- Use a heat resistant detection cable, well insulated to the ground and protected from humidity or water in general.
- Ignition cable has to be kept far from other conductors to reduce the emission of electromagnetic interference.

In case of leakage between live and earth the voltage on the ionization probe can be reduced until it causes the lockout of the control, because of the impossibility of detecting the flame signal.

CHECKING AT START

Always check the control before the first start and also after any replacement or a long period of non-operation of the system. Before any ignition attempt make sure that the combustion chamber is free from gas.

Then make sure that:

- if the starting attempt occurs without gas supply the control performs a lockout after safety time;
- when stopping the gas flow while the control is in running state the supply to the gas valve is interrupted within 1 second and after a recycling the control proceeds to lockout;
- operating times and sequence are suitable for the control box used;
- the flame signal level is high enough (see Fig. 6 for the measuring method to be adapted in case of MICROFLAT controllers type FR and Fig. 7 in case of MICROFLAT controllers type PR);

! ATTENTION !!!
 The flame signal measurement can be carried out only if the detection electrode and the discharge electrode are separate.
 Do not introduce measurement instruments in case of single-electrode applications to avoid any danger that could threaten the worker and the same instrument

- the ignition probes are adjusted in the most stable way for a spark gap between 2-4 mm;
- the intervention of adjusters, limiters or safety devices causes a safety shutdown according to the application.

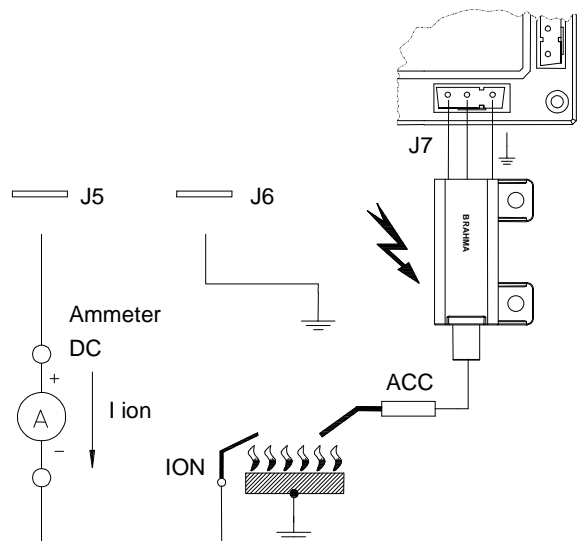

Fig.6 – Flame signal measurement method in “FR” controllers

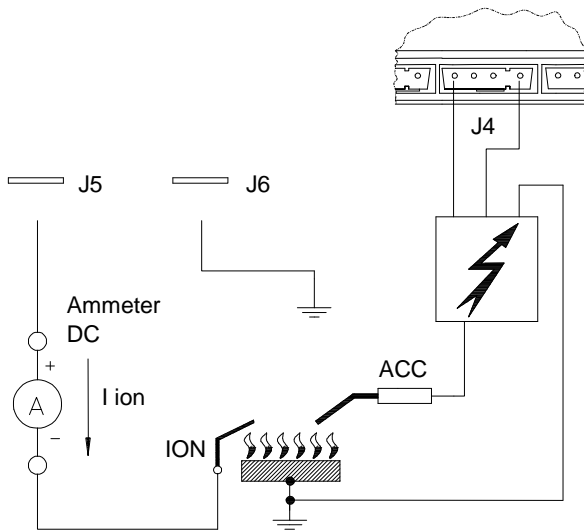

Fig.7 – Flame signal measurement method in “PR” controllers

OPERATION

At every start the control unit proceeds to a self-checking of its own components. During waiting or prepurge time (TW/TP) the operation of the flame signal amplifier is checked. A parasitic flame signal or a fault in the amplifier leading to the same condition prevent the control from starting.

In the types with fan control, before the beginning of prepurge time the air pressure switch contacts are checked to prove their "no air flow" state. Only if the test is positive is the fan started and with the air pressure switch in "air flow" state prepurge time begins. During prepurge time in the control units with electrical reset the lockout signal is switched on.

At the end of waiting or prepurge time the VG1 gas valve is energized and the remote ignition device TR2 is operated. In this way safety time (TS) begins. If a flame signal is detected during safety time, the ignition device is inhibited and, in the suitable models, the main valve (VG2) is supplied or the independent auxiliary contact will switch from off to flame detected position.

On the contrary, if no flame signal is detected during safety time, the control proceeds to lockout, the VG1 gas valve and the ignition device are switched off while the lockout signal is supplied.

Flame failure during safety time causes the ignition device to be re-activated within one second.

The attached operating cycle diagrams are useful to understand how each control operates.

MANUAL RESET – CONTROLLER RESET

When the controller proceeds to the lockout condition, it's necessary to wait 10 seconds before attempting to reset it; if this time interval is not observed then it won't be possible to restart the system.

In general the reset button must be in sight and near to the appliance. Resetting can occur by means of a conscious manual action and not by means of automatic devices like thermostats or timers.

ELECTRICAL RESET – CONTROLLER RESET

the controller reset is accomplished by interrupting and then restoring the power supply. The independent manual reset function is not included in these models; therefore they must be used only in the appliances where resetting through shut off is allowed by the European standards.



NOTES FOR DISPOSAL OPERATIONS

Since the controller contains electronic components, it must not be disposed of as a common domestic waste. For the correct disposal operation it's necessary to refer to the local rules concerning special waste.

CONTROLLERS DENOMINATION

Type					Options						
(1)	(2)	(3)	(4)	(5)	(6)	(7)	(8)	(9)	(10)	(11)	(12)

Type description

- (1) **Usage**
C Wall-hung boilers
S General applications (concerning only "FR" types)
M Single-electrode applications (only for "FR" types)
- (2) **Reset**
M Manual
E Electrical
- (3) **Burner type**
1 Without fan
3 With fan
- (4) **Gas valves**
1 Single flame
2 Dual flame
- (5) **Igniter**
FR BRAHMA remote igniter type TR2
PR Remote igniter with line voltage power supply

Options description

- (6) **Controller conformity**
Controller in compliance with EN 298:1993 (controller employable exclusively as a spare part)
Controller in compliance with EN 298:2003
- (7) **Connections type**
Stocco-Stelvio connectors
X Molex connectors
- (8) **Resistor connected in series to VG2**
Not available
W Available
- (9) **Resistor connected in series to VG1**
Not available
V Available
- (10) **Protection against connection reversal of the lockout signal and the reset button**
Not available
R Available
- (11) **Ignition voltage**
15 Kv (standard)
H 18 kV
L 12 kV
- (12) **Spark repetition frequency**
25 Hz (standard)
nn The number indicated the spark frequency in Herz

CONNECTION DIAGRAMS

Versions WITHOUT fan

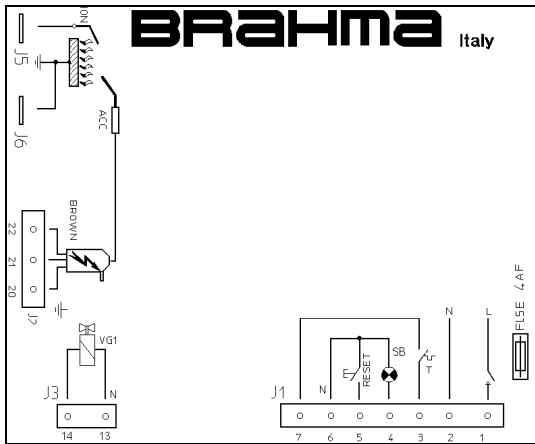

TYPE CM11FR

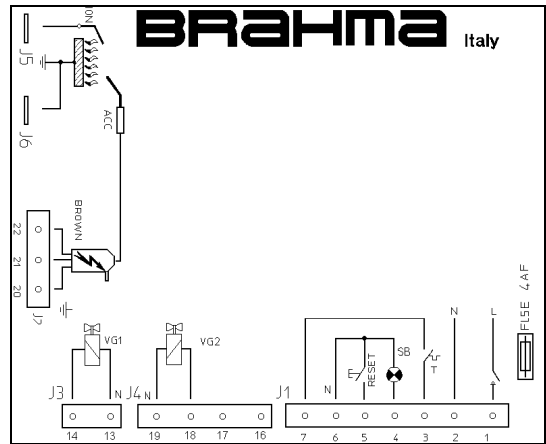

TYPE CM12FR

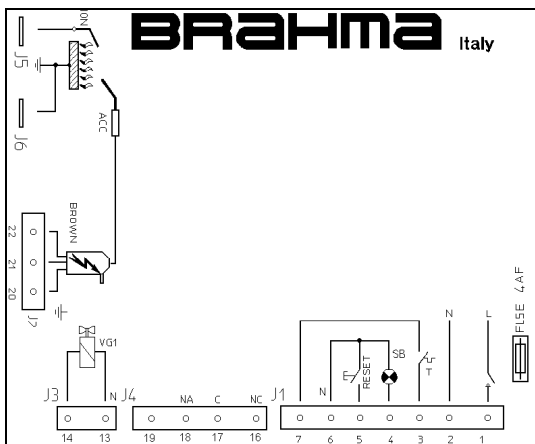

TYPE SM11FR

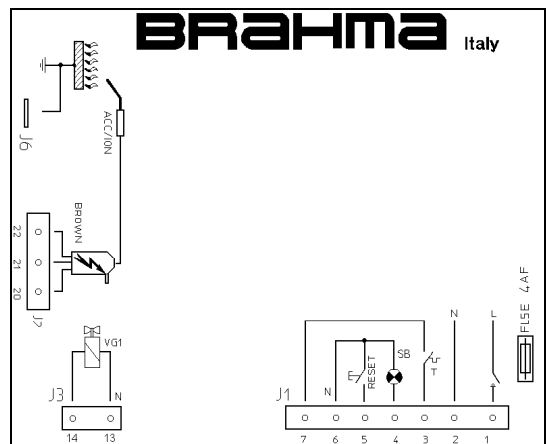

TYPE MM11FR

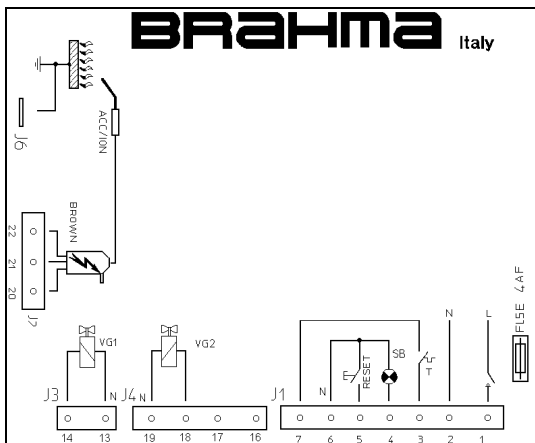

TYPE MM12FR

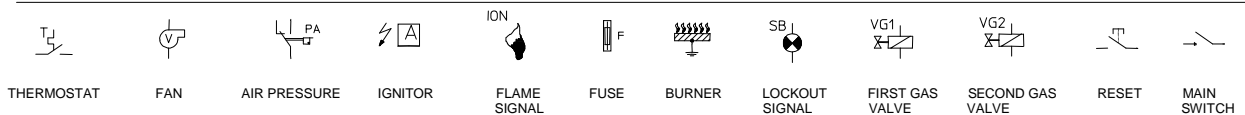

CONNECTION DIAGRAMS

Versions WITH fan

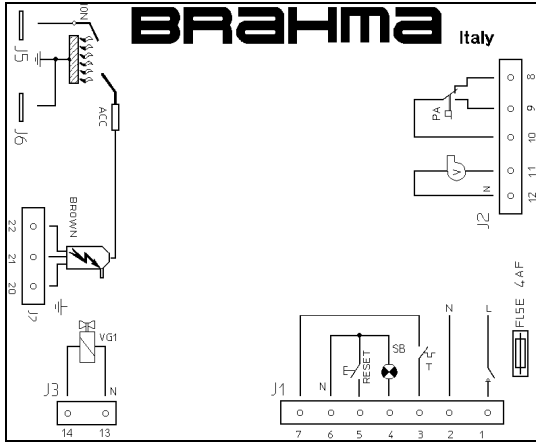

TYPE CM31FR

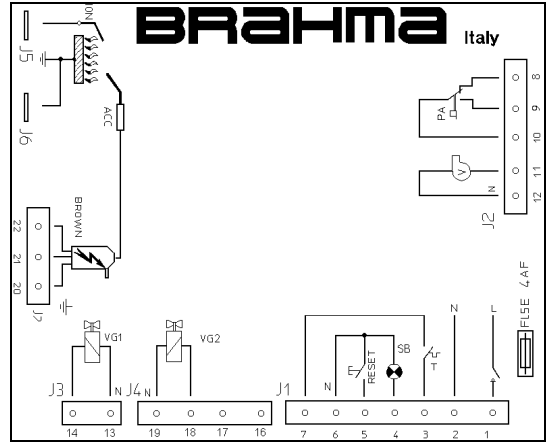

TYPE CM32FR

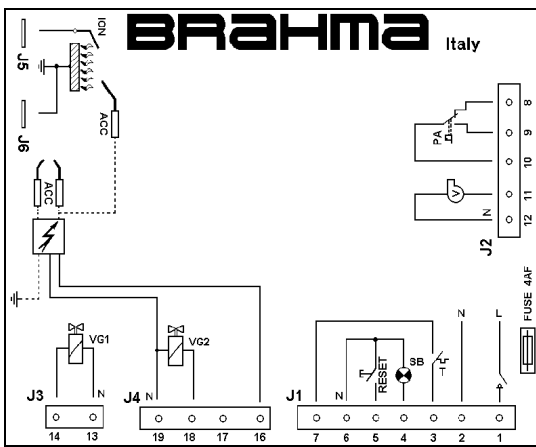

TYPE CM32PR

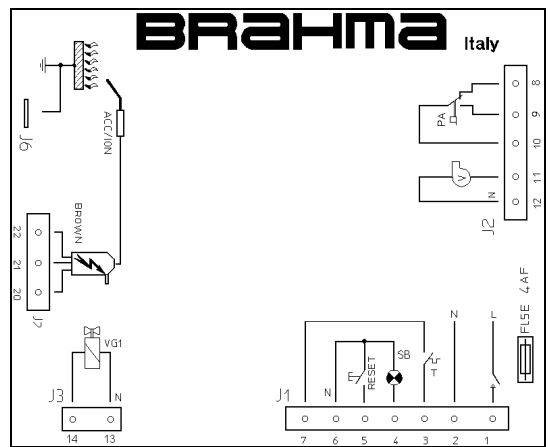

TYPE MM31FR

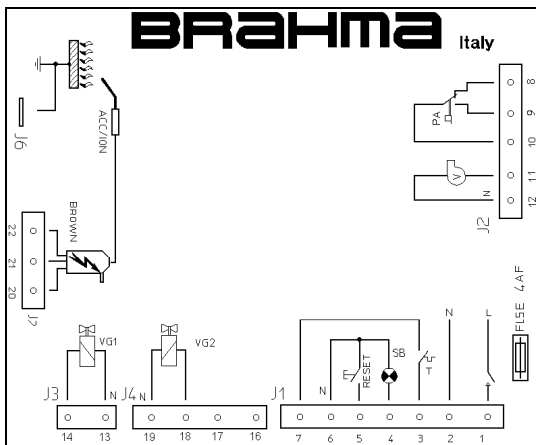

TYPE MM32FR

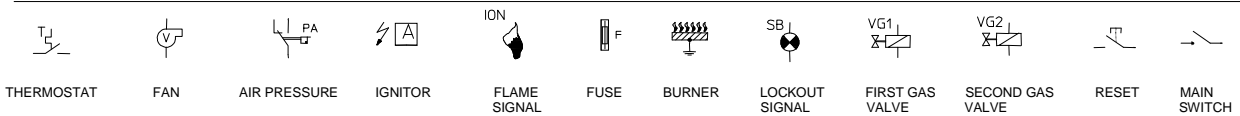

! **IMPORTANT NOTE**
 In the electrical reset versions (in compliance only to the EN 298:1993 and employable as spare parts) the reset button symbol isn't shown

OPERATION DIAGRAMS

Versions WITHOUT fan

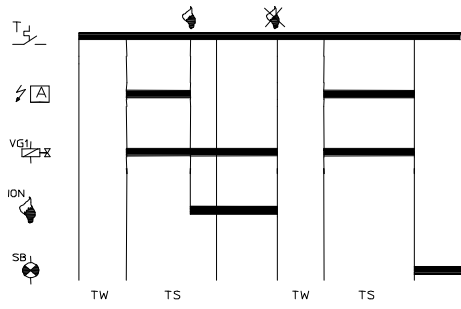

TYPE CM11FR - MM11FR - CM11PR

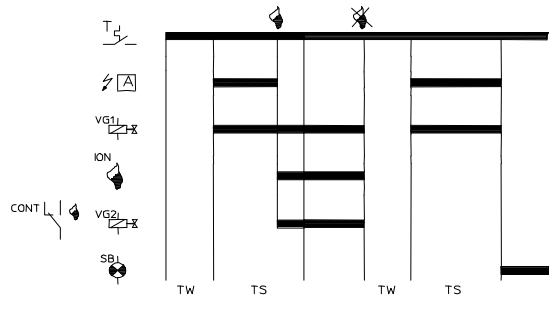

TYPE CM12FR - MM12FR - CM12PR - SM11FR

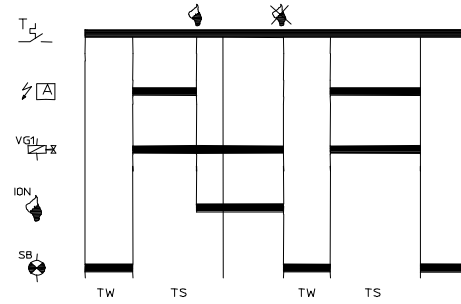

TYPE CE11FR - ME11FR - CE11PR

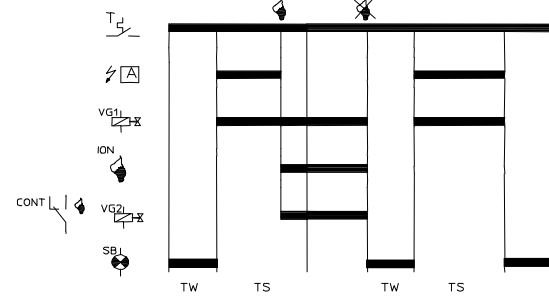

TYPE CE12FR - ME12FR - CE12PR - SE11FR

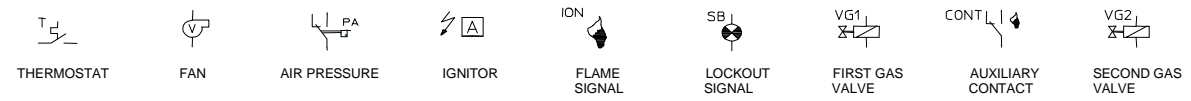

OPERATION DIAGRAM

Versions WITH fan

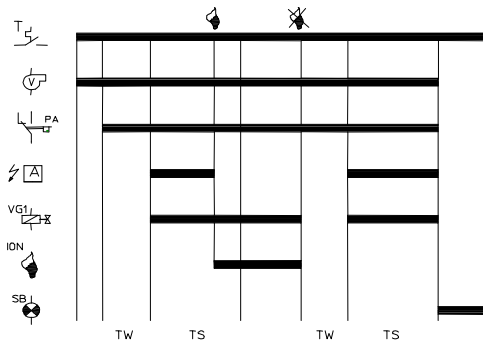

TYPE CM31FR - MM31FR - CM31PR

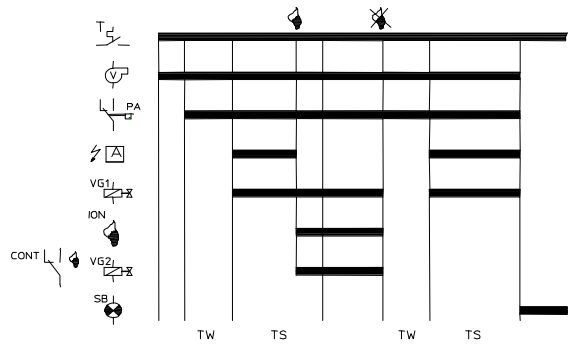

TYPE CM32FR - MM32FR - CM32PR - SM31FR

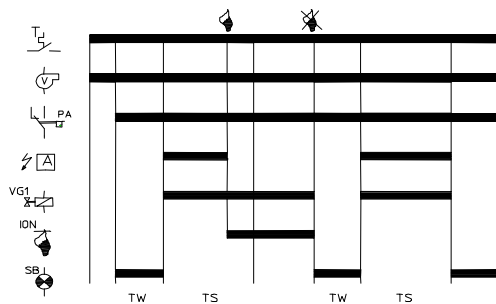

TYPE CE31FR - ME31FR - CE31PR

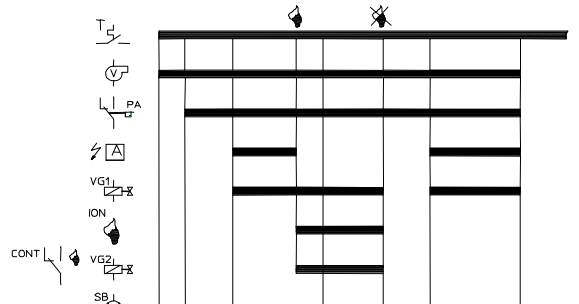

TYPE CE32FR - ME32FR - CE32PR - SE31FR



ATTENTION -> Company Brahma S.p.A. declines any responsibility for any damage resulting from the Customer's interfering with the device

BRAHMA S.p.A.
 Via del Pontiere, 31
 37045 Legnago (VR)
 Tel. +39 0442 635211 - Telefax +39 0442 25683
<http://www.brahma.it>
 E-mail : brahma@brahma.it

2011/07/20 Subject to amendments without notice