

# DR67 SERIES | 25/30 AMPS

## DIN RAIL MOUNT SOLID STATE RELAYS

### Introduction

The DR67 is a compact 3-phase solid state relay in a DIN rail 67.5mm wide package with output ratings up to 30 Amps per channel @ 40°C. Its built-in overvoltage protection and the optional overtemperature protection make it suitable for demanding heating, motion and lighting applications. It's easy to install and its large cage clamp terminals allow connecting wires up to 2 AWG size on the output terminals without the use of any additional accessories, therefore reducing installation cost and time.

UL listed and VDE certified, the DR67 is a powerful and versatile solid state relay with superior performance when compared to previous generations and competitor products.



### Features

- 3-Phase AC Output DIN Rail Mount SSRs
- Output ratings up to 30 Amps at 600 VAC
- 2 & 3 controlled Legs option
- Over Temperature protection w/alarm (optional)
- Built-in overvoltage protection
- IP20 touch-safe housing
- AC or DC control
- cULus listed and VDE approved

### Applications

- Plastic injection molding equipment
- Packaging equipment
- Industrial ovens
- Lighting control
- Professional cooking equipment
- Pump control
- Conveyor drives
- HVAC&R

**NOVA22**



### PRODUCT SELECTION

Control Voltage	25A	30A
4-32 VDC	DR6760D25P	DR6760D30P
90-280 VAC/VDC	DR6760A25P	DR6760A30P



## ORDERING OPTIONS

Example : DR6760A25RPTA

Description of part number example

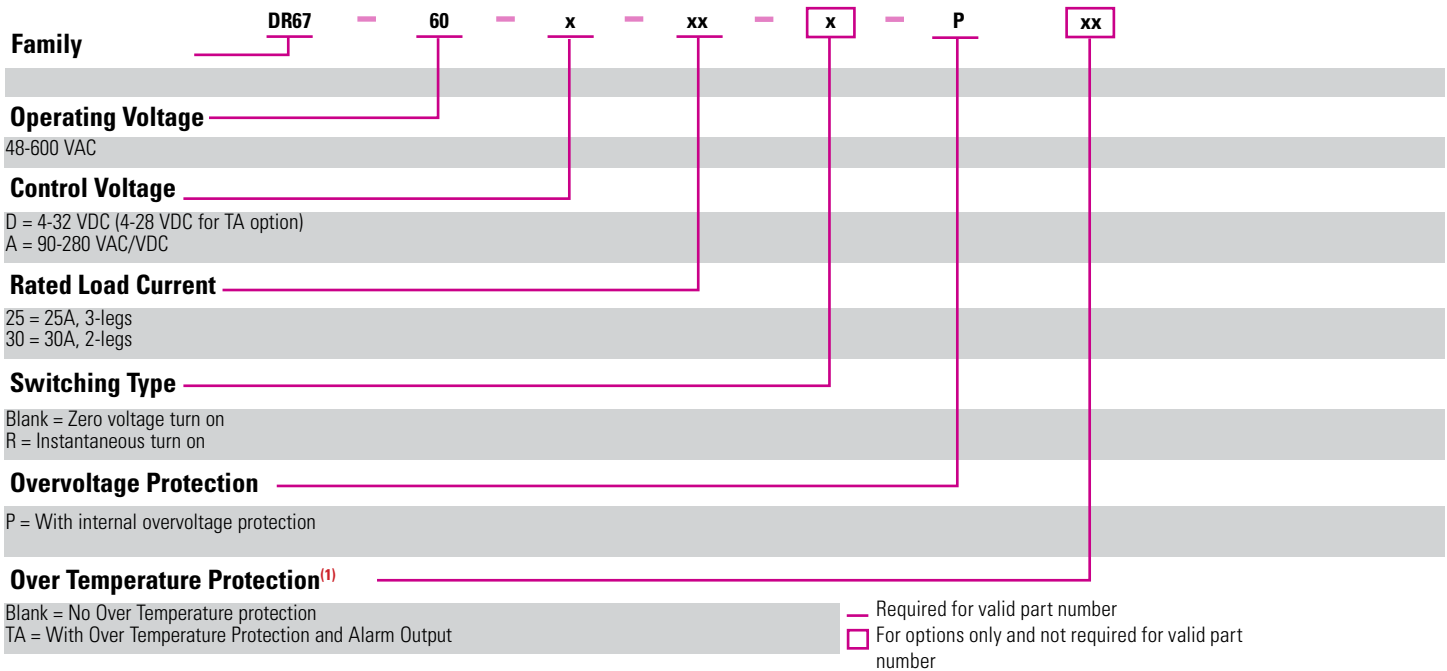

## SPECIFICATIONS

### Output <sup>(2)</sup>

Description	25A	30A
<b>Operating Voltage (47-440Hz) [V<sub>RMS</sub>]</b>	48-600	48-600
<b>Transient Overvoltage [Vpk] <sup>(3)</sup></b>	1200	1200
<b>Maximum Off-State Leakage Current @ Rated Voltage [mA<sub>RMS</sub>]</b>	1	1
<b>Minimum Off-State dV/dt @ Maximum Rated Voltage [V/μsec]</b>	500	500
<b>Load Current, General Use UL508/LC A IEC62314 @ 40°C [A<sub>RMS</sub>]</b>	25	30
<b>Load Current, Motor Starting UL508 FLA/LC B IEC62314 @ 40°C [ARMS]</b>	12/6.8	12/6.8
<b>Minimum Load Current [mA<sub>RMS</sub>]</b>	100	100
<b>Maximum 1 Cycle Surge Current (50/60Hz) [A<sub>pk</sub>]</b>	716/750	716/750
<b>Maximum On-State Voltage Drop @ Rated Current [V<sub>RMS</sub>]</b>	1.15	1.20
<b>Maximum 1/2 Cycle I<sup>2</sup> t for Fusing (50/60Hz) [A<sup>2</sup> sec]</b>	2563/2343	2563/2343
<b>Minimum Power Factor (at Maximum Load)</b>	0.5	0.5
<b>Motor Rating UL 508: 120 VAC / 240 VAC / 480 VAC [HP]</b>	1.5/3.0/7.5	1.5/3.0/7.5
<b>Motor Rating IEC62314: 240 VAC / 400 VAC / 500 VAC [kW]</b>	1.5/3.0/4.0	1.5/3.0/4.0

## Input <sup>(1)</sup>

Description	DR6760Dxxx		DR6760Axxx	
	wo-TA Option	w-TA Option	wo-TA Option	w-TA Option
Control Voltage Range	4-32 VDC <sup>(4)</sup>	4-28 VDC <sup>(4)</sup>	90-280 VAC/VDC	
Maximum Reverse Voltage	-32 VDC		-	
Minimum Turn-On Voltage	4 VDC		90 VAC/VDC	
Must Turn-Off Voltage	1 VDC		5 VAC/VDC	
Minimum Input Current (for on-state)	25 mA	20 mA	1 mA	1 mA
Maximum Input Current	40 mA	50 mA	4 mA	8 mA
Nominal Input Impedance	Current Limited		Switching mode	
Maximum Turn-On Time [msec]	1/2 Cycle <sup>(5)</sup>		10	
Maximum Turn-Off Time [msec]	1/2 Cycle		20	

## Alarm <sup>(2)</sup>

Description	DR6760Dxxx	DR6760Axxx
Output type	Solid State	Solid State
Maximum Output Voltage	60 VDC	400 VDC / 265 VAC
Maximum Alarm Output Current [mA]	60	60

## General <sup>(2)</sup>

Description	Parameters
Dielectric Strength, Input to Output (50/60Hz)	4k V <sub>RMS</sub>
Dielectric Strength, Input/Output to Case (50/60Hz)	4k V <sub>RMS</sub>
Minimum Insulation Resistance (@ 500 VDC)	10 <sup>9</sup> Ohms
Maximum Capacitance, Input/Output	25 pF
Ambient Operating Temperature Range	-40 to 80 °C
Ambient Storage Temperature Range	-40 to 100 °C
Short Circuit Current Rating <sup>(6)</sup>	100 kA
Weight (typical)	31 oz (880 g)
Housing Material	UL94 V-0
Heat Sink Material	Aluminum
DIN Rail Clip Material	Zinc Plated Steel
Hardware Finish	Nickel Plating
Input Terminal Screw Torque Range (lb-in/Nm)	5/0.5
Load Terminal Screw Torque Range (lb-in/Nm)	18-20/2.0-2.2
Humidity per IEC 60068-2-78 <sup>(7)</sup>	93%
LED Input Status Indicator	See status chart
Overvoltage Category	III
Impulse Withstand Voltage According to IEC 60664-1	6 kV



# EQUIVALENT CIRCUIT BLOCK DIAGRAMS/WIRING DIAGRAMS

**DR6760X25**  
**DR6760X30**

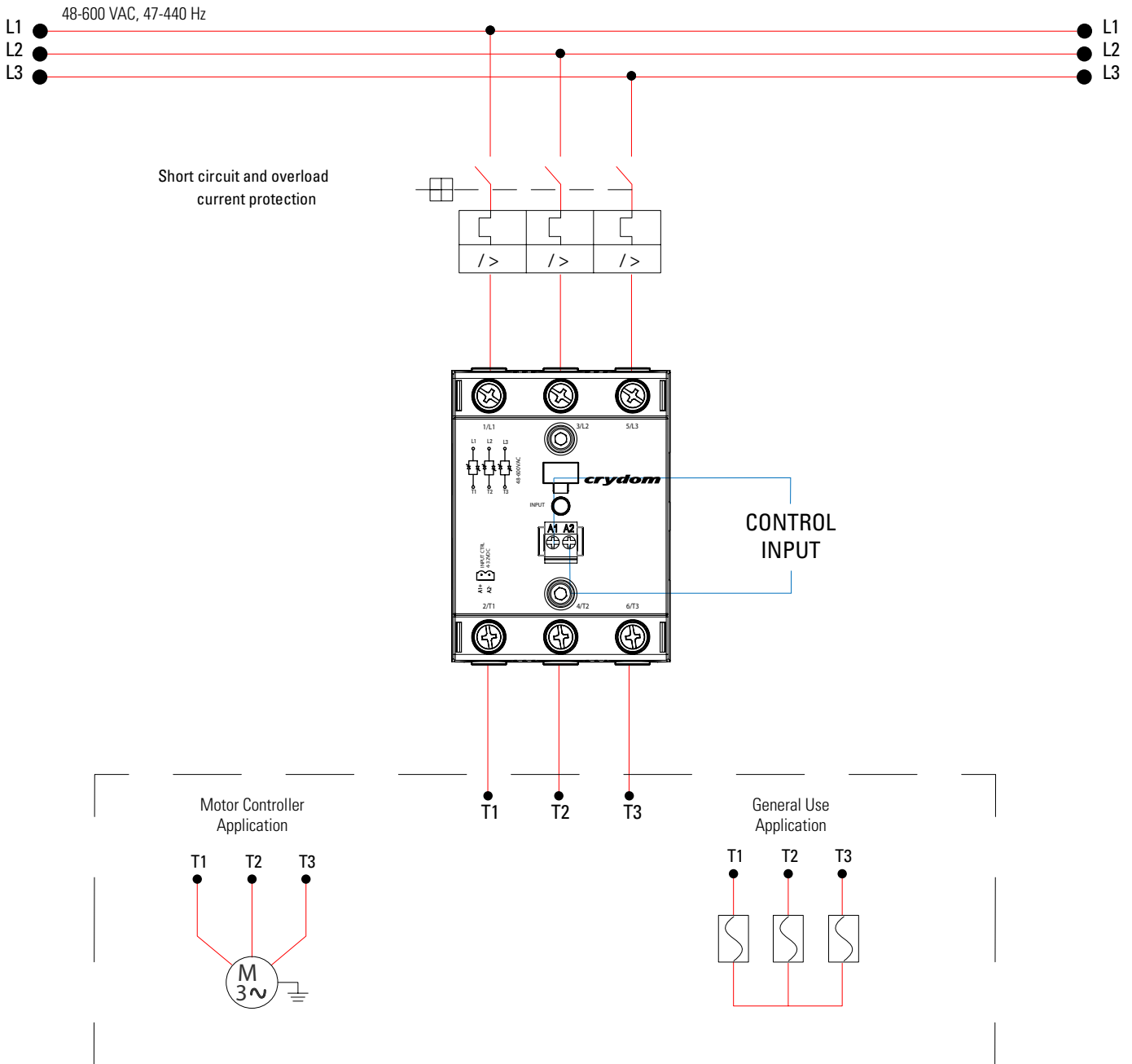

DR6760X30  
(2 CONTROLLED LEGS)

DR6760X25  
(3 CONTROLLED LEGS)

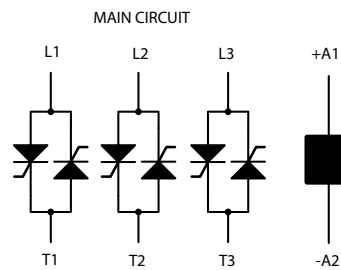
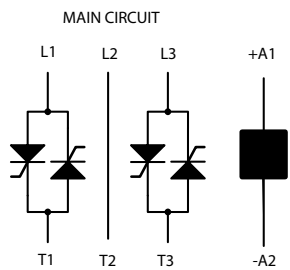

**DR6760X25TA**  
**DR6760X30TA**

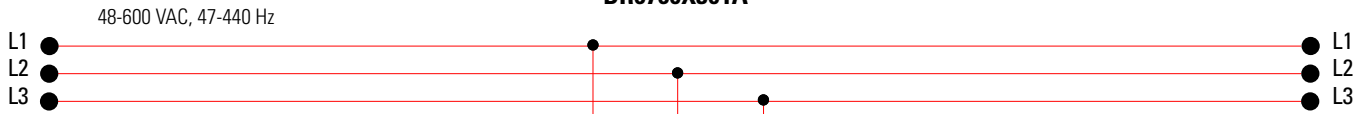

Short circuit and overload  
current protection

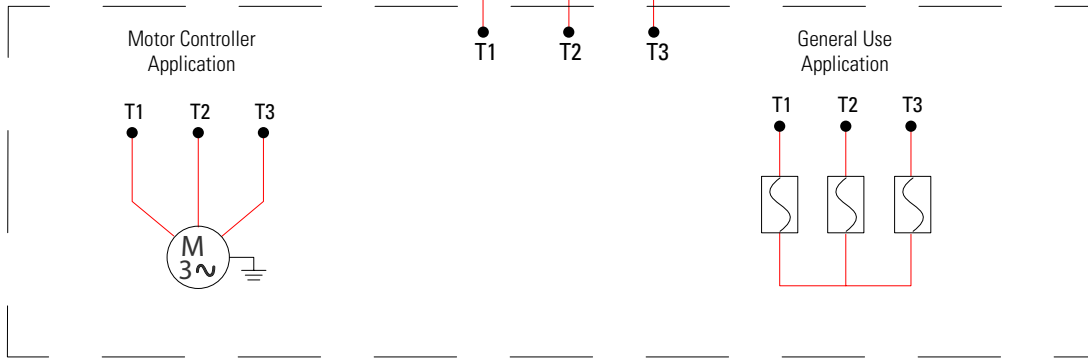
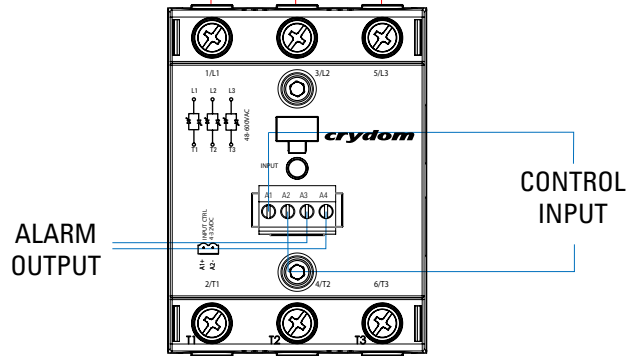
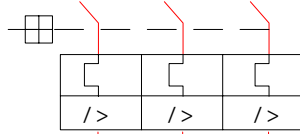

DR6760X30TA  
(2 CONTROLLED LEGS )

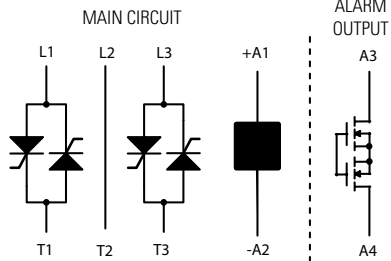

DR6760X25TA  
(3 CONTROLLED LEGS )

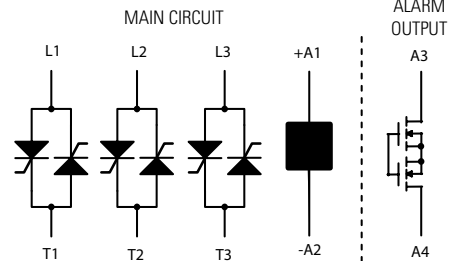



# MECHANICAL SPECIFICATIONS

Tolerances:  $\pm 0.02$  in / 0.5 mm  
All dimensions are in inches [mm]

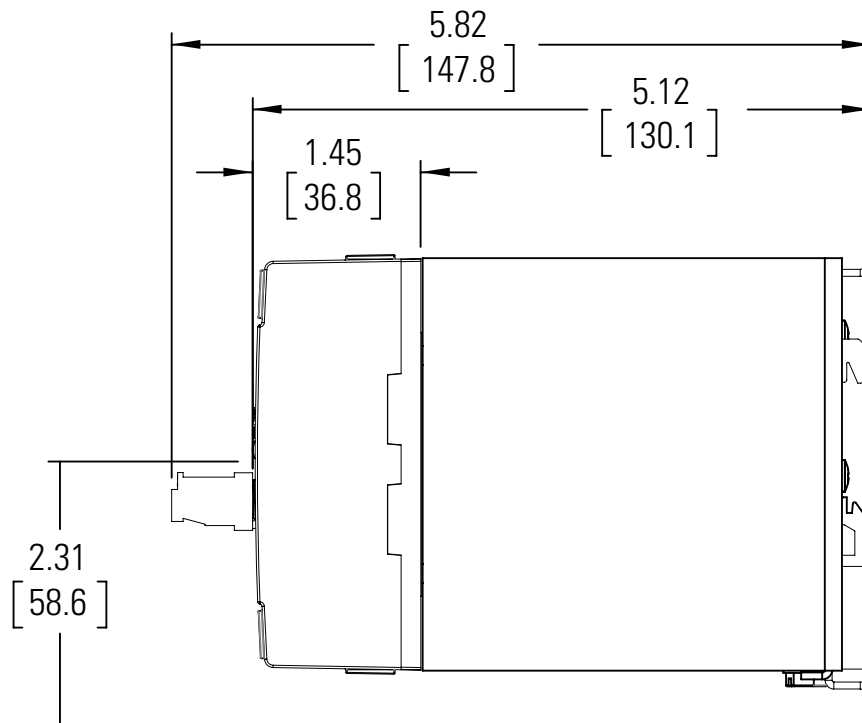
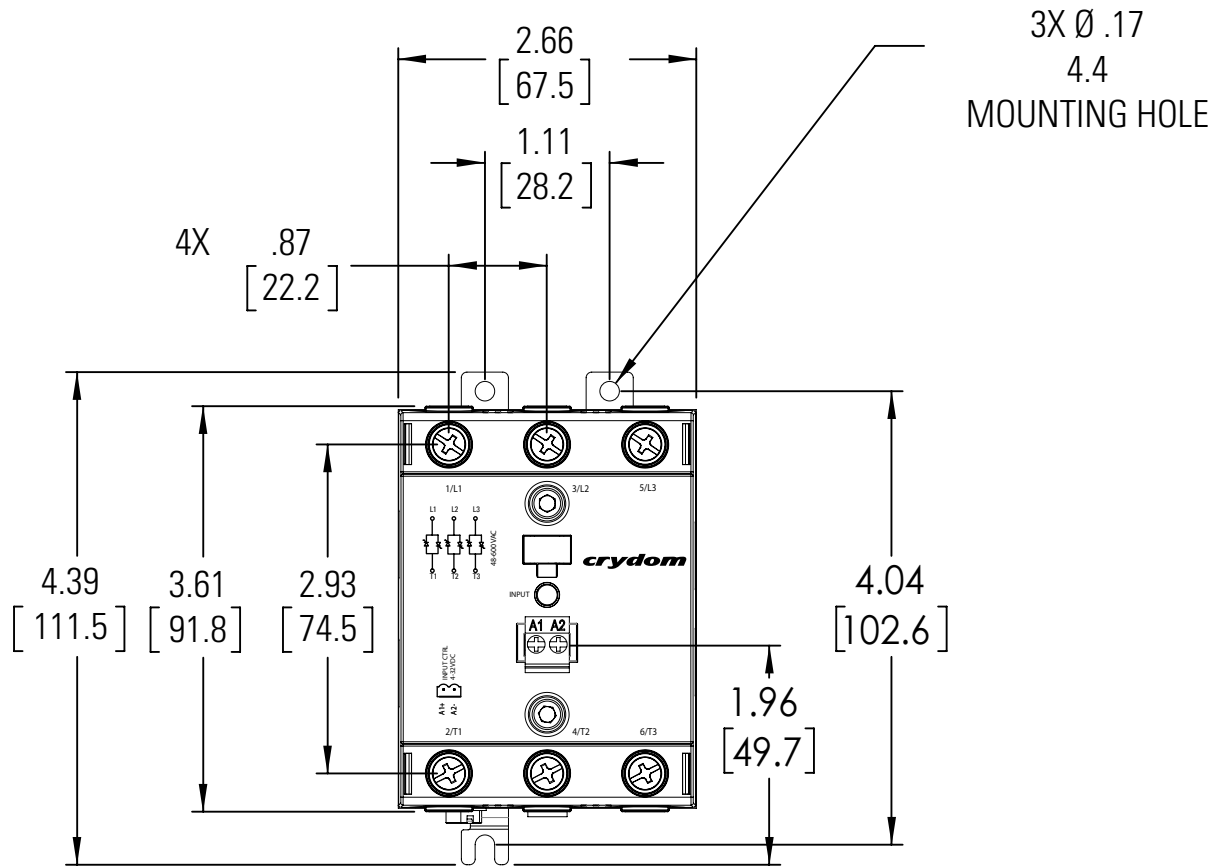



## SURGE CURRENT INFORMATION<sup>(8)</sup>

### 25A & 30A

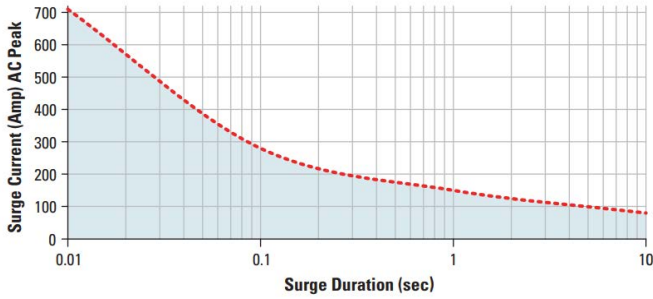

## THERMAL DERATE INFORMATION

### DR6760x25

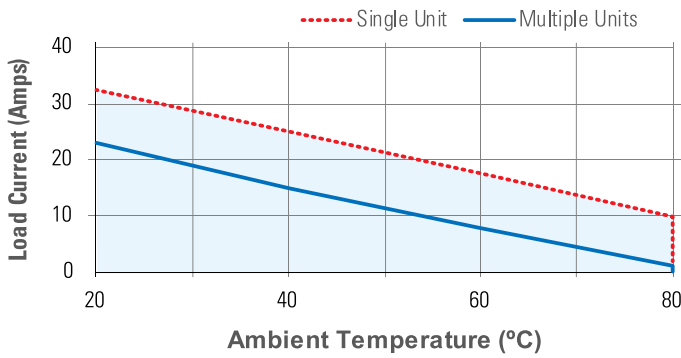

### DR6760x30

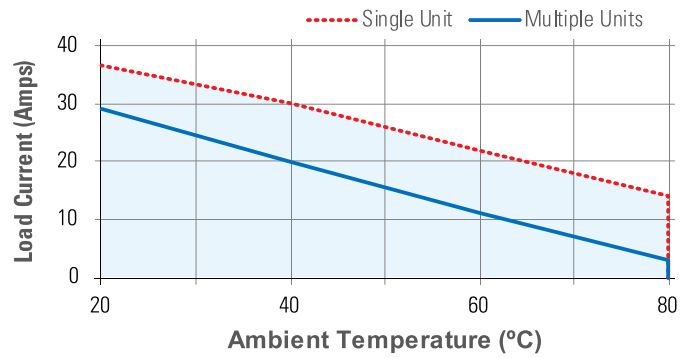

## STATUS CHART

(only for models with overtemperature protection)

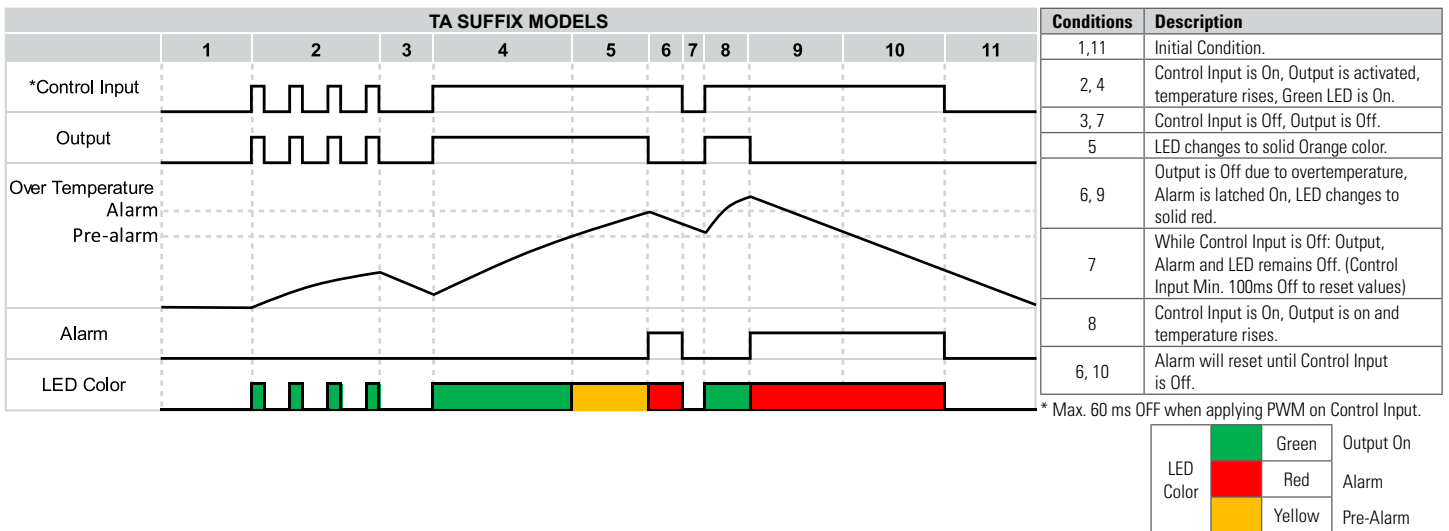



# INSTALLATION INSTRUCTIONS

## Mounting on DIN Rail

- Locate rail and align with non moveable end of DR67 DIN clip.
- Using reasonable force, push DR67 in the direction of the arrow (as shown in fig.1).
- For removal pull release tag by moving blade of screwdriver in direction of arrow and pull it away from DIN rail.

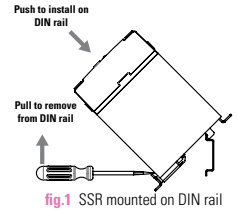

## Mounting on Panel

- Locate the panel section on which the DR67 SSR will be mounted on (as shown in fig.2)
- DIN clip includes tabs for this type of mounting. Tab holes have a diameter of 4.5 mm. You will need three screws (not included) no larger than that to mount the SSR onto panel.
- Align SSR tabs with panel surface and screw both top and bottom sides. Recommended torque is 12 lb-in (1.36 Nm).

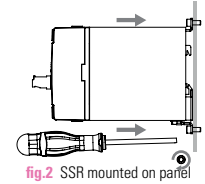

## Wiring Instructions

- Recommended wire sizes as shown in TABLE 1
- Maximum terminal screw torque input terminal 5 lb-in (0.5 Nm) (screw terminal only)
- Maximum terminal screw torque load terminal 18-20 lb-in (2.0-2.2 Nm)
- Strip length for input terminals: Per manufacturer specifications
- Strip length for load terminals: 10mm min.
- Use only copper conductors rated for 75°C
- If multiple units are installed be sure to follow derating curves.

## WARNING!!

- Removing product from 35mm Rail incorrectly by not using the appropriate tool, would damage the latching system.

**Table 1. Wire Size & Pull Out Strength**

Terminal Configuration	Recommended Wire Size (Solid/Stranded)	Wire Pull-Out Strength (lb)(N)*	
Output	1 x 18 AWG (1 mm <sup>2</sup> ) [minimum]	20 [88]	
	1 x 8 AWG (10 mm <sup>2</sup> )	75 [333]	
	2 x 8 AWG (10 mm <sup>2</sup> )	65 [289]	
	1 x 3 AWG (26.67 mm <sup>2</sup> ) <sup>(1)</sup>	90 [400]	
Input	Screw	30 AWG (0.05 mm <sup>2</sup> ) [minimum]	4.5 [20]
		12 AWG (3.3 mm <sup>2</sup> ) [maximum]	30 [133]
	Spring <sup>(2)</sup>	26 AWG (0.13 mm <sup>2</sup> ) [minimum]	5 [22]
		12 AWG (3.3 mm <sup>2</sup> ) [maximum]	5 [22]

\*Tests performed on Stranded wire

<sup>(1)</sup> Maximum wire size 1 x 2 AWG (35mm<sup>2</sup>)

<sup>(2)</sup> Applicable when using CP202 connector instead of supplied connector



# ACCESSORIES

## Recommended Accessories

<b>Connectors</b>	<b>ID Marker</b>
CP201 CP202	CNLB CNLN CNL2

## Protective Earth Connection

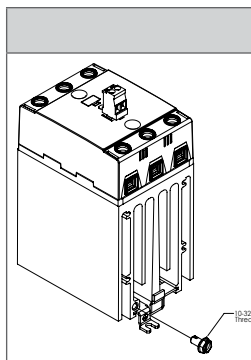

Protective earth (PE) screw type recommended is 10-32 UNC standard not provided with SSR.



Through the use of a DIN rail ground (protective conductor) terminal block, the DIN rail itself can be used as the grounding bus bar. In this case, the zinc plated steel material used for the DIN rail clip of DR67 models, permits a secure path to ground and avoid the need of a further PE connection.









## AGENCY APPROVALS & CERTIFICATIONS

### Approvals (Tested and Certified According To)

 E116949	 40047491
UL 508 and C22.2 No. 14	EN 62314

CONFORMANCES				ENVIRONMENTAL	
<b>Vibration Resistance IEC 60068-2-6</b> <sup>(9)(10)</sup>	<b>Shock Resistance IEC IEC 60068-2-27</b> <sup>(9)(10)</sup>	<b>Resistances to heat and fire</b>			
Amplitude Range: 10-55 Hz, Displacement 0.75mm	Peak Acceleration: 15g, Duration 11ms.	IEC 60335-1, Section 30	Directive 2006/95/EC	Directive 2011/65/EU	GBT 26572-2011

Electromagnetic Compatibility				
Generic Standard	Immunity Tests	Test Specification Level		Performance
 IEC 61000-6-2 Immunity for Industrial Environments"	Electrostatic Discharge IEC 61000-4-2	8kV air discharge		Criterion A
		6kV contact discharge		Criterion A
	Fast transient (burst) IEC 61000-4-4	Output	2kV, 5kHz, 100kHz	Criterion B
		Input	1kV, 5kHz, 100kHz	Criterion B
	Surge IEC 61000-4-5	Output	1kV Line to Line	Criterion B
			2kV Line to Earth	Criterion B
		AC Input Option	1kV Line to Line	Criterion A
			2kV Line to Earth	Criterion A



## GENERAL NOTES

- (1) Option available upon demand. Please contact your local Sensata representative for additional information.
- (2) All parameters at 25°C unless otherwise specified per Channel.
- (3) Output will self trigger between 900-1200 Vpk, not suitable for capacitive loads.
- (4) Increase minimum voltage by 1 V for operations from -20 to -40°C.
- (5) Turn-on time for Instantaneous turn-on versions is 0.1 msec.
- (6) When protected with the appropriate class and rated fuse. For detailed info please contact Sensata Technical Support.
- (7) No freezing or condensation allowed.
- (8) For single surge pulse Tc=25°C; Tj=125°C. For AC Output SSRs, AC RMS value of surge current equals the peak value divided by 2 (1.414).
- (9) Except when device is attached to a panel or flat surface with screws.
- (10) Test conditions: Din Rail stoppers side by side between a single SSR.



## WARNINGS



### RISK OF MATERIAL DAMAGE AND HOT ENCLOSURE

- The product's side panels may be hot, allow the product to cool before touching
- Follow proper mounting instructions including torque values
- Do not allow liquids or foreign objects to enter this product

**Failure to follow these instructions can result in serious injury, or equipment damage.**



### HAZARD OF ELECTRIC SHOCK, EXPLOSION OR ARC FLASH

- Disconnect all power before installing or working with this equipment
- Verify all connections and replace all covers before turning on power

**Failure to follow these instructions will result in death or serious injury.**

Sensata Technologies, Inc. ("Sensata") data sheets are solely intended to assist designers ("Buyers") who are developing systems that incorporate Sensata products (also referred to herein as "components"). Buyer understands and agrees that Buyer remains responsible for using its independent analysis, evaluation and judgment in designing Buyer's systems and products. Sensata data sheets have been created using standard laboratory conditions and engineering practices. Sensata has not conducted any testing other than that specifically described in the published documentation for a particular data sheet. Sensata may make corrections, enhancements, improvements and other changes to its data sheets or components without notice.

Buyers are authorized to use Sensata data sheets with the Sensata component(s) identified in each particular data sheet. HOWEVER, NO OTHER LICENSE, EXPRESS OR IMPLIED, BY ESTOPPEL OR OTHERWISE TO ANY OTHER SENSATA INTELLECTUAL PROPERTY RIGHT, AND NO LICENSE TO ANY THIRD PARTY TECHNOLOGY OR INTELLECTUAL PROPERTY RIGHT, IS GRANTED HEREIN. SENSATA DATA SHEETS ARE PROVIDED "AS IS". SENSATA MAKES NO WARRANTIES OR REPRESENTATIONS WITH REGARD TO THE DATA SHEETS OR USE OF THE DATA SHEETS, EXPRESS, IMPLIED OR STATUTORY, INCLUDING ACCURACY OR COMPLETENESS. SENSATA DISCLAIMS ANY WARRANTY OF TITLE AND ANY IMPLIED WARRANTIES OF MERCHANTABILITY, FITNESS FOR A PARTICULAR PURPOSE, QUIET ENJOYMENT, QUIET POSSESSION, AND NON-INFRINGEMENT OF ANY THIRD PARTY INTELLECTUAL PROPERTY RIGHTS WITH REGARD TO SENSATA DATA SHEETS OR USE THEREOF.

All products are sold subject to Sensata's terms and conditions of sale supplied at [www.sensata.com](http://www.sensata.com) SENSATA ASSUMES NO LIABILITY FOR APPLICATIONS ASSISTANCE OR THE DESIGN OF BUYERS' PRODUCTS. BUYER ACKNOWLEDGES AND AGREES THAT IT IS SOLELY RESPONSIBLE FOR COMPLIANCE WITH ALL LEGAL, REGULATORY AND SAFETY-RELATED REQUIREMENTS CONCERNING ITS PRODUCTS, AND ANY USE OF SENSATA COMPONENTS IN ITS APPLICATIONS, NOTWITHSTANDING ANY APPLICATIONS-RELATED INFORMATION OR SUPPORT THAT MAY BE PROVIDED BY SENSATA.

Mailing Address: Sensata Technologies, Inc., 529 Pleasant Street, Attleboro, MA 02703, USA.

## CONTACT US

### Americas

+1 (877) 502 5500 – Option 2  
[sales.crydom@sensata.com](mailto:sales.crydom@sensata.com)

### Europe, Middle East & Africa

+44 (1202) 416170  
[ssr-info.eu@sensata.com](mailto:ssr-info.eu@sensata.com)

### Asia Pacific

[sales.isasia@list.sensata.com](mailto:sales.isasia@list.sensata.com)  
 China +86 (21) 2306 1500  
 Japan +81 (45) 277 7117  
 Korea +82 (31) 601 2004  
 India +91 (80) 67920890  
 Rest of Asia +886 (2) 27602006  
 ext 2808

# Mouser Electronics

Authorized Distributor

Click to View Pricing, Inventory, Delivery & Lifecycle Information:

[Sensata:](#)

[DR6760D25P](#) [DR6760D25RP](#) [DR6760D30RP](#) [DR6760D30P](#) [DR6760A25P](#) [DR6760A25RP](#) [DR6760A30P](#)  
[DR6760A30RP](#)