

Panasonic
ideas for life

High capacity SSR,
both tab and screw
terminals available

AQ-R RELAYS

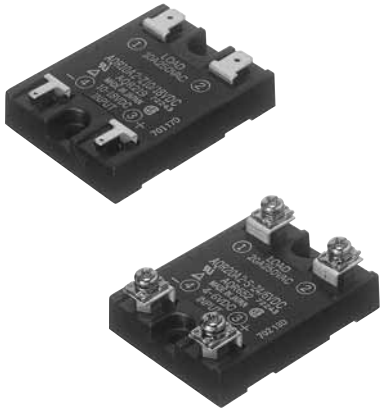

FEATURES

1. Two types of terminal shape: Plug-in terminal and Screw terminal (30 A, 40 A is screw terminal types only)
2. Flat type of SSR possible by aluminium printed circuit board
3. High dielectric strength of 1,500 V between input and output. 4,000 V available for 10A, 15A, 20A devices.
4. Heat sink and DIN mounting rail and terminal cover are available as accessories

APPLICATIONS

1. Molding machine (heater control)
2. Temperature controlled bath (heater control)
3. Printing machine (heater control)
4. Machine tool (motor control)

Compliance with RoHS Directive

ORDERING INFORMATION

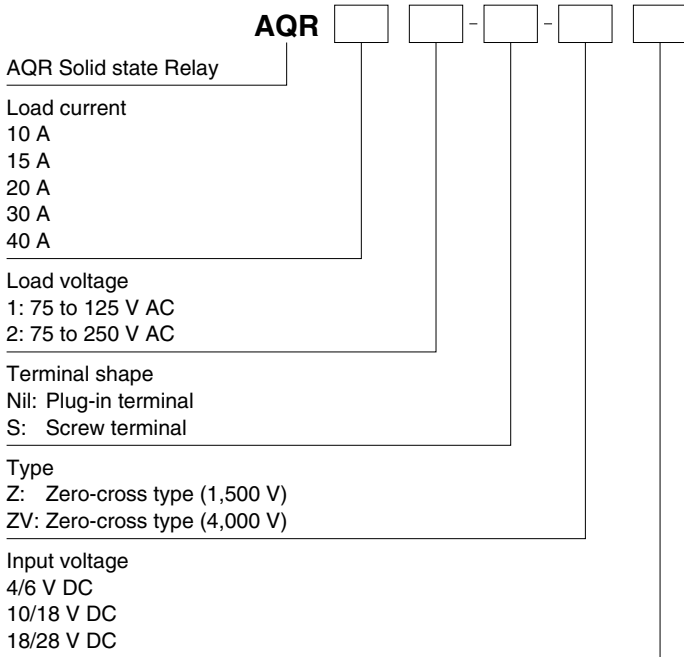

AQ-R

TYPES

1. Tab terminal type

Type	Load current	Load voltage	Input voltage	Standard (1,500V AC)	Reinforced (4,000V AC)
				Part No.	Part No.
Zero-cross	10 A	75 to 125V AC	4 to 6V DC	AQR10A1-Z4/6VDC	—
			10 to 18V DC	AQR10A1-Z10/18VDC	—
			18 to 28V DC	AQR10A1-Z18/28VDC	—
		75 to 250V AC	4 to 6V DC	AQR10A2-Z4/6VDC	AQR10A2-ZV4/6VDC
			10 to 18V DC	AQR10A2-Z10/18VDC	AQR10A2-ZV10/18VDC
			18 to 28V DC	AQR10A2-Z18/28VDC	AQR10A2-ZV18/28VDC
	15 A	75 to 125 V AC	4 to 6V DC	AQR15A1-Z4/6VDC	—
			10 to 18V DC	AQR15A1-Z10/18VDC	—
			18 to 28V DC	AQR15A1-Z18/28VDC	—
		75 to 250 V AC	4 to 6V DC	AQR15A2-Z4/6VDC	AQR15A2-ZV4/6VDC
			10 to 18V DC	AQR15A2-Z10/18VDC	AQR15A2-ZV10/18VDC
			18 to 28V DC	AQR15A2-Z18/28VDC	AQR15A2-ZV18/28VDC
	20 A	75 to 125 V AC	4 to 6V DC	AQR20A1-Z4/6VDC	—
			10 to 18V DC	AQR20A1-Z10/18VDC	—
			18 to 28V DC	AQR20A1-Z18/28VDC	—
		75 to 250 V AC	4 to 6V DC	AQR20A2-Z4/6VDC	AQR20A2-ZV4/6VDC
			10 to 18V DC	AQR20A2-Z10/18VDC	AQR20A2-ZV10/18VDC
			18 to 28V DC	AQR20A2-Z18/28VDC	AQR20A2-ZV18/28VDC

Standard packing: Carton 10 pcs., Case: 100 pcs.

2. Screw-terminal type

Type	Load current	Load voltage	Input voltage	Standard (1,500V AC)	Reinforced (4,000V AC)
				Part No.	Part No.
Zero-cross	10 A	75 to 125 V AC	4 to 6V DC	AQR10A1-S-Z4/6VDC	—
			10 to 18V DC	AQR10A1-S-Z10/18VDC	—
			18 to 28V DC	AQR10A1-S-Z18/28VDC	—
		75 to 250 V AC	4 to 6V DC	AQR10A2-S-Z4/6VDC	AQR10A2-S-ZV4/6VDC
			10 to 18V DC	AQR10A2-S-Z10/18VDC	AQR10A2-S-ZV10/18VDC
			18 to 28V DC	AQR10A2-S-Z18/28VDC	AQR10A2-S-ZV18/28VDC
	15 A	75 to 125 V AC	4 to 6V DC	AQR15A1-S-Z4/6VDC	—
			10 to 18V DC	AQR15A1-S-Z10/18VDC	—
			18 to 28V DC	AQR15A1-S-Z18/28VDC	—
		75 to 250 V AC	4 to 6V DC	AQR15A2-S-Z4/6VDC	AQR15A2-S-ZV4/6VDC
			10 to 18V DC	AQR15A2-S-Z10/18VDC	AQR15A2-S-ZV10/18VDC
			18 to 28V DC	AQR15A2-S-Z18/28VDC	AQR15A2-S-ZV18/28VDC
	20 A	75 to 125 V AC	4 to 6V DC	AQR20A1-S-Z4/6VDC	—
			10 to 18V DC	AQR20A1-S-Z10/18VDC	—
			18 to 28V DC	AQR20A1-S-Z18/28VDC	—
		75 to 250 V AC	4 to 6V DC	AQR20A2-S-Z4/6VDC	AQR20A2-S-ZV4/6VDC
			10 to 18V DC	AQR20A2-S-Z10/18VDC	AQR20A2-S-ZV10/18VDC
			18 to 28V DC	AQR20A2-S-Z18/28VDC	AQR20A2-S-ZV18/28VDC
	30 A	75 to 250 V AC	4 to 6V DC	AQR30A2-S-Z4/6VDC	—
			10 to 18V DC	AQR30A2-S-Z10/18VDC	—
			18 to 28V DC	AQR30A2-S-Z18/28VDC	—
	40 A	75 to 250 V AC	4 to 6V DC	AQR40A2-S-Z4/6VDC	—
			10 to 18V DC	AQR40A2-S-Z10/18VDC	—
			18 to 28V DC	AQR40A2-S-Z18/28VDC	—

Standard packing: Carton 10 pcs., Case: 100 pcs.

SPECIFICATIONS

1. Ratings (at 20°C 68°F, Input ripple: 1% or less)

1) 10 A type

Part No.		AQR10A1-Z4/ 6VDC AQR10A1-S-Z4/ 6VDC	AQR10A1-Z10/ 18VDC AQR10A1-S-Z10/ 18VDC	AQR10A1-Z18/ 28VDC AQR10A1-S-Z18/ 28VDC	AQR10A2-Z4/ 6VDC AQR10A2-S-Z4/ 6VDC AQR10A2-S-ZV4/ 6VDC	AQR10A2-Z10/ 18VDC AQR10A2-S-Z10/ 18VDC AQR10A2-S- ZV10/18VDC	AQR10A2-Z18/ 28VDC AQR10A2-S-Z18/ 28VDC AQR10A2-S- ZV18/28VDC	Remarks		
Items	Input voltage	4 to 6V DC	10 to 18V DC	18 to 28V DC	4 to 6V DC	10 to 18V DC	18 to 28V DC			
	Input impedance	Approx. 0.26 kΩ	Approx. 0.86 kΩ	Approx. 1.36 kΩ	Approx. 0.26 kΩ	Approx. 0.86 kΩ	Approx. 1.36 kΩ	*1		
	Drop-out voltage, min.	1 V								
Load side	Max. load current	10 A*2							Ta = Max. 40°C 104°F	
	Load voltage	75 to 125 V AC			75 to 250 V AC					
	Frequency	45 to 65 Hz								
	Repetitive peak voltage	400 V			600 V					
	Non-repetitive surge current	100 A*3							In one cycle at 60 Hz	
	Max. "OFF-state" leakage current	2.5 mA (when 100 V AC applied)			5 mA (when 200 V AC applied)					at 60 Hz
	Max. "ON-state" voltage drop	1.6 V							at max. carrying current	
	Min. load current	100 mA*4								
	OFF-state dV/dt	100 V/μs								

2) 15 A type

Part No.		AQR15A1-Z4/ 6VDC AQR15A1-S-Z4/ 6VDC	AQR15A1-Z10/ 18VDC AQR15A1-S-Z10/ 18VDC	AQR15A1-Z18/ 28VDC AQR15A1-S-Z18/ 28VDC	AQR15A2-Z4/ 6VDC AQR15A2-S-Z4/ 6VDC AQR15A2-S-ZV4/ 6VDC	AQR15A2-Z10/ 18VDC AQR15A2-S-Z10/ 18VDC AQR15A2-S- ZV10/18VDC	AQR15A2-Z18/ 28VDC AQR15A2-S-Z18/ 28VDC AQR15A2-S- ZV18/28VDC	Remarks		
Items	Input voltage	4 to 6V DC	10 to 18V DC	18 to 28V DC	4 to 6V DC	10 to 18V DC	18 to 28V DC			
	Input impedance	Approx. 0.26 kΩ	Approx. 0.86 kΩ	Approx. 1.36 kΩ	Approx. 0.26 kΩ	Approx. 0.86 kΩ	Approx. 1.36 kΩ	*1		
	Drop-out voltage, min.	1 V								
Load side	Max. load current	15 A*2							Ta = Max. 40°C 104°F	
	Load voltage	75 to 125 V AC			75 to 250 V AC					
	Frequency	45 to 65 Hz								
	Repetitive peak voltage	400 V			600 V					
	Non-repetitive surge current	150 A*3							In one cycle at 60 Hz	
	Max. "OFF-state" leakage current	2.5 mA (when 100 V AC applied)			5 mA (when 200 V AC applied)					at 60 Hz
	Max. "ON-state" voltage drop	1.6 V							at max. carrying current	
	Min. load current	100 mA*4								
	OFF-state dV/dt	100 V/μs								

Notes: *1. Refer to REFERENCE DATA "3. Input current vs. input voltage".

*2. Refer to REFERENCE DATA "1. Load current vs. ambient temperature".

*3. Refer to REFERENCE DATA "2. Non-repetitive surge current vs. carrying time".

*4. When the load current is less than the rated minimum load current, please refer to "Cautions for Use of SSR".

AQ-R

3) 20 A type

Part No.		AQR20A1-Z4/ 6VDC AQR20A1-S-Z4/ 6VDC	AQR20A1-Z10/ 18VDC AQR20A1-S-Z10/ 18VDC	AQR20A1-Z18/ 28VDC AQR20A1-S-Z18/ 28VDC	AQR20A2-Z4/ 6VDC AQR20A2-ZV4/ 6VDC AQR20A2-S-ZV4/ 6VDC	AQR20A2-Z10/ 18VDC AQR20A2-ZV10/ 18VDC AQR20A2-S-Z10/ 18VDC AQR20A2-S- ZV10/18VDC	AQR20A2-Z18/ 28VDC AQR20A2-ZV18/ 28VDC AQR20A2-S-Z18/ 28VDC AQR20A2-S- ZV18/28VDC	Remarks	
Items	Input voltage	4 to 6V DC	10 to 18V DC	18 to 28V DC	4 to 6V DC	10 to 18V DC	18 to 28V DC		
Input side	Input impedance	Approx. 0.26 kΩ	Approx. 0.86 kΩ	Approx. 1.36 kΩ	Approx. 0.26 kΩ	Approx. 0.86 kΩ	Approx. 1.36 kΩ	*1	
	Drop-out voltage, min.	1 V							
	Max. load current	20 A*2							Ta = Max. 40°C 104°F
Load side	Load voltage	75 to 125 V AC			75 to 250 V AC				
	Frequency	45 to 65 Hz							
	Repetitive peak voltage	400 V			600 V				
	Non-repetitive surge current	200 A*3							In one cycle at 60 Hz
	Max. "OFF-state" leakage current	2.5 mA (when 100 V AC applied)			5 mA (when 200 V AC applied)				at 60 Hz
	Max. "ON-state" voltage drop	1.6 V							at max. carrying current
	Min. load current	100 mA*4							
	OFF-state dV/dt	100 V/μs							

4) 30 A type and 40 A type

Part No.		AQR30A2-S-Z4/ 6VDC	AQR30A2-S-Z10/ 18VDC	AQR30A2-S-Z18/ 28VDC	AQR40A2-S-Z4/ 6VDC	AQR40A2-S-Z10/ 18VDC	AQR40A2-S-Z18/ 28VDC	Remarks	
Items	Input voltage	4 to 6V DC	10 to 18V DC	18 to 28V DC	4 to 6V DC	10 to 18V DC	18 to 28V DC		
Input side	Input impedance	Approx. 0.26 kΩ	Approx. 0.86 kΩ	Approx. 1.36 kΩ	Approx. 0.26 kΩ	Approx. 0.86 kΩ	Approx. 1.36 kΩ	*1	
	Drop-out voltage, min.	1 V							
	Max. load current	30 A*2			40 A*2				Ta = Max. 40°C 104°F
Load side	Load voltage	75 to 250 V AC							
	Frequency	45 to 65 Hz							
	Non-repetitive surge current	300 A*3			400 A*3				In one cycle at 60 Hz
	Max. "OFF-state" leakage current	5 mA (when 200 V AC applied)							at 60 Hz
	Max. "ON-state" voltage drop	1.6 V							at max. carrying current
	Min. load current	120 mA*4							

Notes: *1. Refer to REFERENCE DATA "3. Input current vs. input voltage".

*2. Refer to REFERENCE DATA "1. Load current vs. ambient temperature".

*3. Refer to REFERENCE DATA "2. Non-repetitive surge current vs. carrying time".

*4. When the load current is less than the rated minimum load current, please refer to "Cautions for Use of SSR".

2. Characteristics (at 20°C 68°F, Input ripple: 1% or less)

Item	Type	Zero-cross type		Remarks
		Standard type	Reinforced type	
Operate time, max.		1/2 cycle of voltage sine wave + 1 ms		
Release time, max.		1/2 cycle of voltage sine wave + 1 ms		
Insulation resistance, min., Initial		100 M Ω between input, output and case		at 500V DC
Breakdown voltage		1,500 V AC between input, output and case	4,000 V AC between input, output and case	For 1 min.
Vibration resistance	Functional	10 to 55 Hz at double amplitude of 2 mm*		1 hour for X, Y, Z axes
	Destructive	10 to 55 Hz at double amplitude of 2 mm*		10 minutes for X, Y, Z axes
Shock resistance	Functional	Min. 980 m/s ² {100 G}		5 time each for X, Y, Z axes
	Destructive	Min. 980 m/s ² {100 G}		4 time each for X, Y, Z axes
Ambient temperature		-20°C to +80°C -4°F to +176°F		
Storage temperature		-25°C to +85°C -13°F to +185°F		
Operational method		Zero-cross (Turn-ON and Turn-OFF)		

Note: *30A and 40A type is 10 to 55 Hz at double amplitude of 1.5 mm .059 inch.

REFERENCE DATA

1. Load current vs. ambient temperature

Use load current within range specified in the figure below.

Tested condition:

With external heat sink

1) (1) 10 A, 15A, 20 A type

- A heat sink; optional heat sink (AQP-HS-J10A) or a 150×150×3.2 mm aluminum sheet (painted black)

(2) 30 A, 40 A type

Shown with standard heat sink (AQP-HS-30/40A)

2) If attached to a heat sink, use a heat-conductive compound or similar coating to improve cooling.

Without external heat sink

If the mounting surface is not metallic and a heat sink is not used, expose the bottom surface and plate surface to improve heat dissipation.

The graphs show the characteristics when the relay is mounted as shown in the right figure.

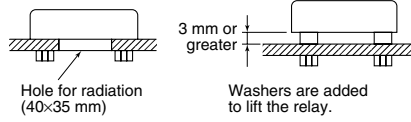

(1) 10 A type

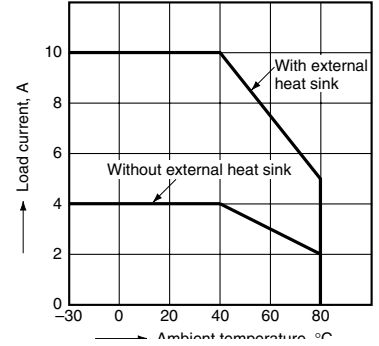

(2) 15 A type

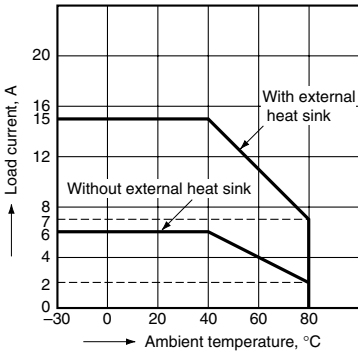

(3) 20 A type

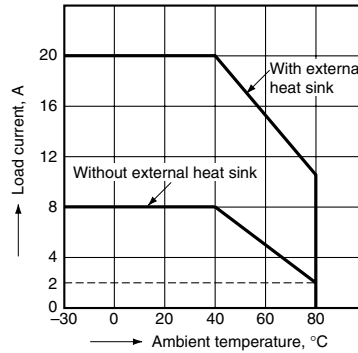

(4) 30 A type

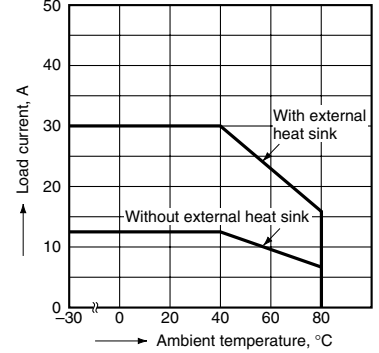

(5) 40 A type

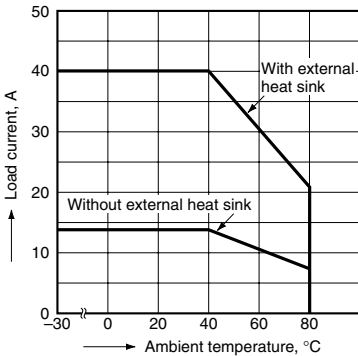

2-1. Non-repetitive surge current vs. carrying time (10 A type)

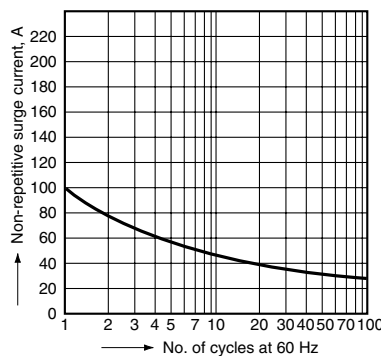

2-2. Non-repetitive surge current vs. carrying time (15 A type)

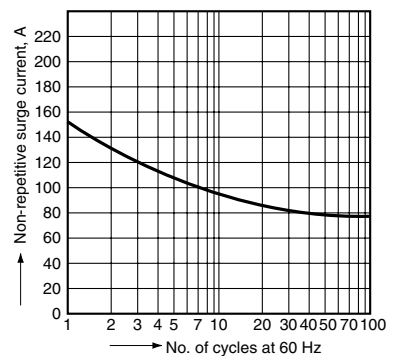

2-3. Non-repetitive surge current vs. carrying time (20 A type)

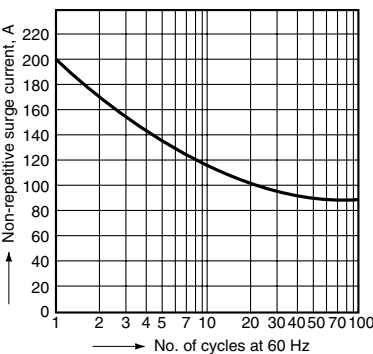

2-4. Non-repetitive surge current vs. carrying time (30 A, 40 A type)

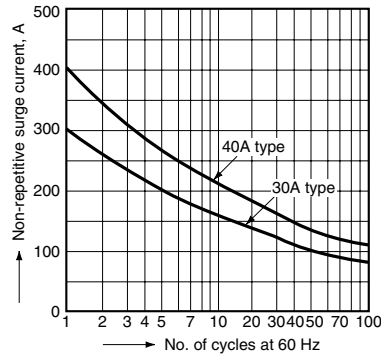

3. Input current vs. input voltage (10 A, 15 A, 20 A, 30 A, 40 A common)

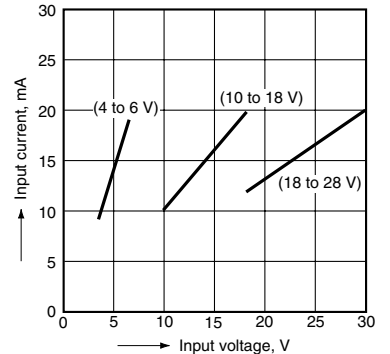

AQ-R

DIMENSIONS (mm inch)

The CAD data of the products with a **CAD Data** mark can be downloaded from: <http://panasonic-electric-works.net/ac>

1. Tab terminal

CAD Data

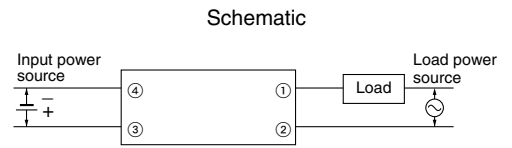
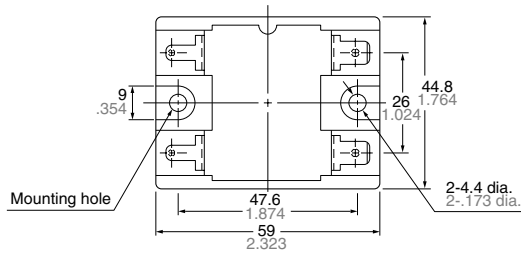

Mounting dimensions (Bottom view)

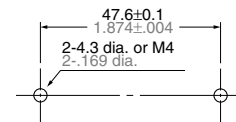

Conform to AMP plug-in terminal #110 series receptacle

Conform to AMP plug-in terminal #250 series receptacle

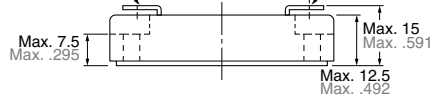

2. Screw terminal

CAD Data

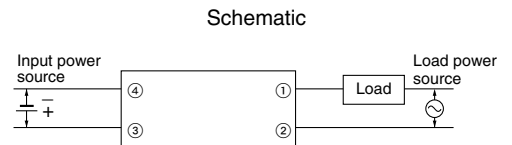
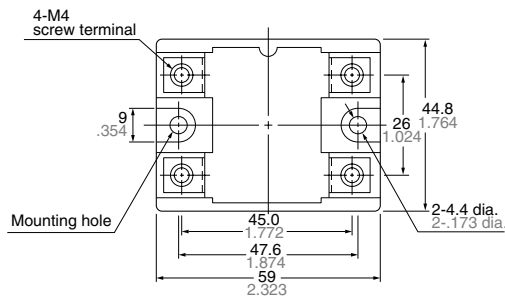

Mounting dimensions (Bottom view)

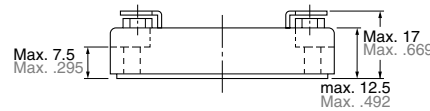
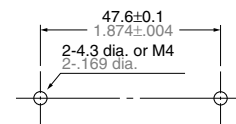

ACCESSORIES

Heat sink (For 10 A, 15A and 20 A)

CAD Data

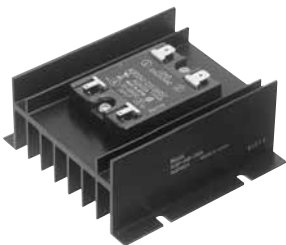

AQP-HS-J10A

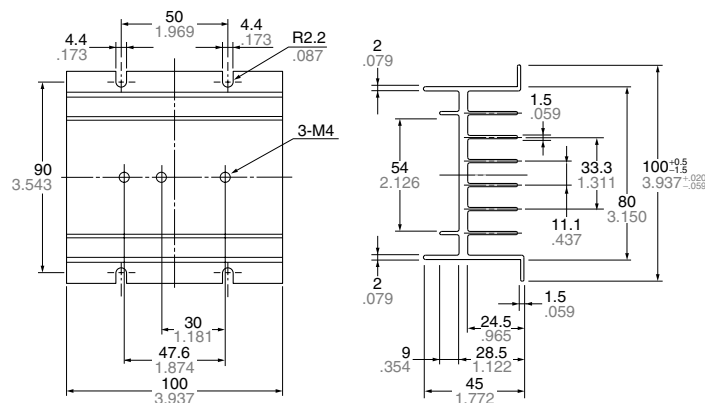

Mounting dimensions (Bottom view)

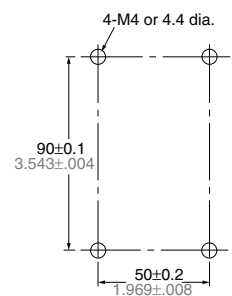

General tolerance: $\pm 0.5 \pm 0.20$

Heat sink (For 30 A, 40 A)

CAD Data



AQP-HS-30/40A

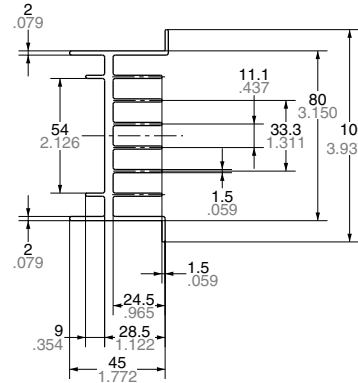
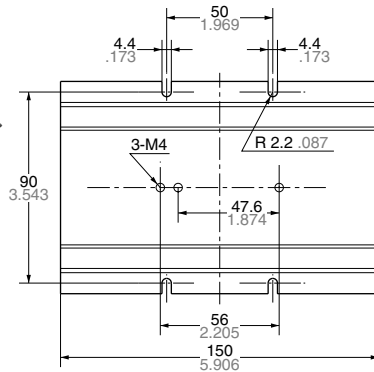

Mounting dimensions
(Bottom view)

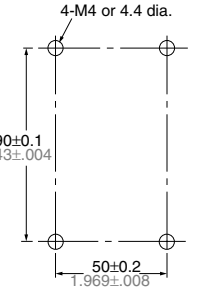

General tolerance: ±0.5 ±.020

With terminal cover

CAD Data

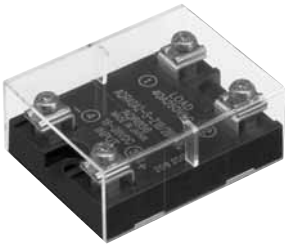

AQP-PC

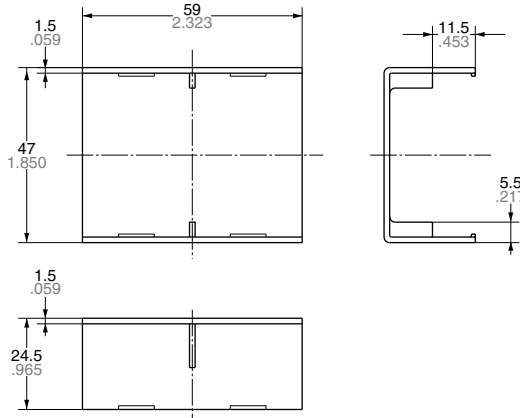

General tolerance: ±0.5 ±.020

DIN rail mounting plate

CAD Data



AQP-DP

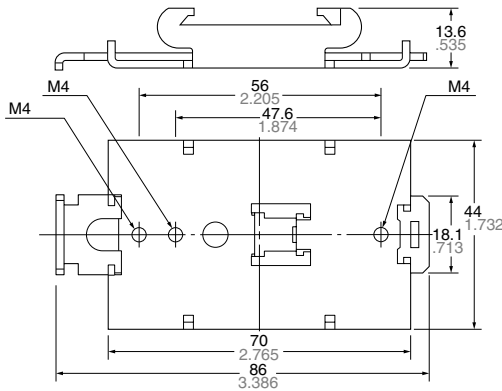

Mounting rail

CAD Data

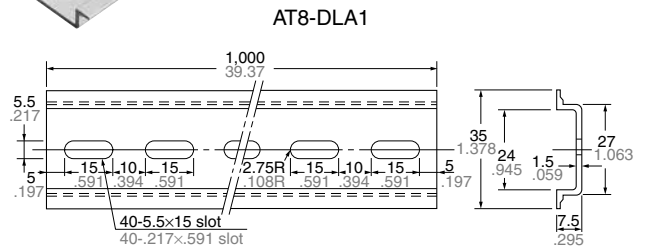

General tolerance: ±0.5 ±.020

AQ-R

Fastening plate

CAD Data



ATA4806

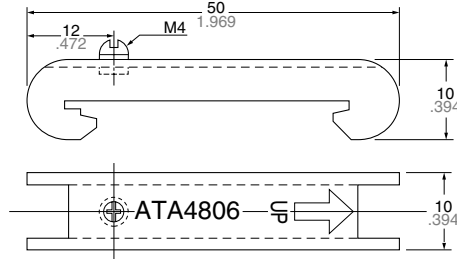

Recommended Temperature Controllers

<KT4H Temperature Controller>

Our temperature controller is recommended for use with our Solid State Relays.

Features

- Data can be collected using the RS485 communications interface via a PLC.
- Improved visibility using a negative type LCD and backlight.
- Depth-wise length (chassis dimension) is 56 mm 2.205 inch.

Substitute part numbers

Power supply	Control output	Part No.
100 to 240 V AC	Relay contact	AKT4H111100

*For detailed product information about temperature controllers, please refer to our website:
http://panasonic-denko.co.jp/ac/e/fasys/component/temperature_controller/

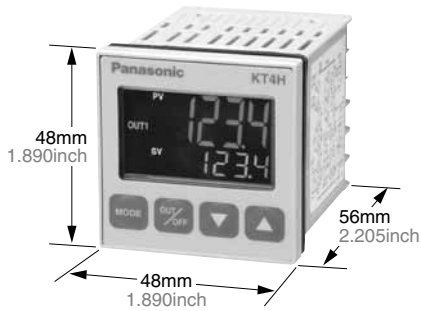

For Cautions for Use.

Mouser Electronics

Authorized Distributor

Click to View Pricing, Inventory, Delivery & Lifecycle Information:

Panasonic:

[AQR40A2-S-Z4/6VDC](#) [AQR40A2-S-Z10/18VDC](#) [AQR10A2-Z4/6VDC](#) [AQR10A2-S-Z18/28VDC](#) [AQR10A2-S-Z10/18VDC](#) [AQR10A2-S-Z4/6VDC](#) [AQR10A1-S-Z18/28VDC](#) [AQR30A2-S-Z18/28VDC](#) [AQR15A1-S-Z4/6VDC](#) [AQR15A2-S-Z10/18VDC](#) [AQR20A2-Z18/28VDC](#) [AQR30A2-S-Z4/6VDC](#) [AQR20A1-S-Z4/6VDC](#) [AQR30A2-S-Z10/18VDC](#) [AQR10A1-S-Z4/6VDC](#) [AQR40A2-S-Z18/28VDC](#) [AQR15A2-S-Z18/28VDC](#) [AQR20A2-S-Z18/28VDC](#) [AQR20A2-S-Z10/18VDC](#)