

New

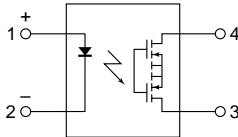

mm inch



Compliance with RoHS Directive

## FEATURES

**1. VSSOP type with further reduction in mounting area**  
4.6 mm<sup>2</sup> mounting area achieved. Approx 29% less than previous product (SON type).  
Contributes to the miniaturization of instruments and higher density mounting.

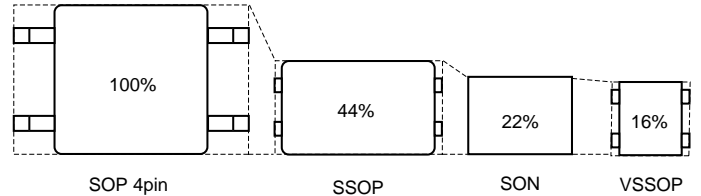

### 2. Low on resistance (R type) available

Variation possible through combinations of output capacitance and On resistance. For more information, please contact our sales office in your area.

### 3. Low on resistance and low output capacitance available at CxR10

[Output capacitance: 14 pF (typical), On resistance: 0.8Ω (typical)]

## TYPICAL APPLICATIONS

### 1. Measuring and testing equipment

IC tester, Probe card, Board tester and other testing equipment

### 2. Telecommunication equipment

\*Does not support automotive applications.

## TYPES

Type		Output rating*1		Part No. (Tape and reel packing style)*2		Packing quantity in the tape and reel
		Load voltage	Load current	Picked from the 1 and 4-pin side	Picked from the 2 and 3-pin side	
AC/DC type	Low on resistance (R type)	40 V	250 mA	AQY221R2TY	AQY221R2TW	1,000 pcs.

Notes: \*1 Indicate the peak AC and DC values.

\*2 Only tape and reel package is available.

For space reasons, only "1R2" is marked on the product as the part number.

## RATING

### 1. Absolute maximum ratings (Ambient temperature: 25°C 77°F)

Item		Symbol	AQY221R2T	Remarks
Input side	LED forward current	I <sub>F</sub>	50 mA	
	LED reverse voltage	V <sub>R</sub>	5 V	
	Peak forward current	I <sub>FP</sub>	1 A	f = 100 Hz, Duty factor = 0.1%
	Power dissipation	P <sub>in</sub>	75 mW	
Output side	Load voltage (peak AC)	V <sub>L</sub>	40 V	
	Continuous load current	I <sub>L</sub>	0.25 A	Peak AC, DC
	Peak load current	I <sub>peak</sub>	0.75 A	100 ms (1shot), V <sub>L</sub> = DC
	Power dissipation	P <sub>out</sub>	250 mW	
Total power dissipation		P <sub>T</sub>	300 mW	
I/O isolation voltage		V <sub>iso</sub>	200 V AC	
Operating temperature		T <sub>opr</sub>	-40°C to +85°C -40°F to +185°F	Non-condensing at low temperatures
Storage temperature		T <sub>stg</sub>	-40°C to +100°C -40°F to +212°F	

# RF VSSOP 1 Form A C×R10 (AQY221R2T)

## 2. Electrical characteristics (Ambient temperature: 25°C 77°F)

Item		Symbol	AQY221R2T	Condition
Input	LED operate current	Typical	0.5 mA	$I_L = \text{Max.}$
		Maximum	3 mA	
	LED turn off current	Minimum	0.1 mA	$I_L = \text{Max.}$
		Typical	0.4 mA	
LED dropout voltage	Typical	1.14 V	$I_F = 5 \text{ mA}$	
	Maximum	1.5 V		
Output	On resistance	Typical	0.8 $\Omega$	$I_F = 5 \text{ mA}, I_L = \text{Max.}$
		Maximum	1.25 $\Omega$	
	Output capacitance	Typical	14 pF	$I_F = 0 \text{ mA}, f = 1 \text{ MHz}, V_B = 0 \text{ V}$
		Maximum	18 pF	
	Off state leakage current	Typical	0.02 nA	$I_F = 0 \text{ mA}, V_L = \text{Max.}$
		Maximum	10 nA	
Transfer characteristics	Turn on time*	Typical	0.1 ms	$I_F = 5 \text{ mA}, V_L = 10 \text{ V}, R_L = 40 \Omega$
		Maximum	0.5 ms	
	Turn off time*	Typical	0.06 ms	$I_F = 5 \text{ mA}, V_L = 10 \text{ V}, R_L = 40 \Omega$
		Maximum	0.2 ms	
	I/O capacitance	Typical	0.4 pF	$f = 1 \text{ MHz}, V_B = 0 \text{ V}$
		Maximum	1.5 pF	

Note: Please refer to the "Schematic and Wiring Diagrams" for connection method.

\*Turn on/Turn off time

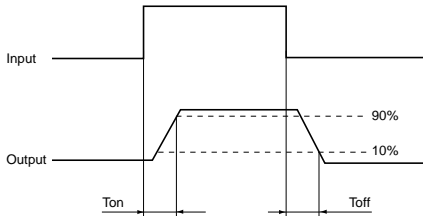

## RECOMMENDED OPERATING CONDITIONS

Please obey the following conditions to ensure proper this device operation and resetting.

Item	Symbol	Recommended value	Unit
Input LED current	$I_F$	5	mA

## REFERENCE DATA

1. Load current vs. ambient temperature characteristics

Allowable ambient temperature: -40°C to +85°C  
-40°F to +185°F

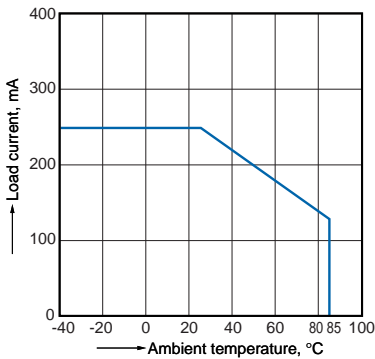

2. Load current vs. Load voltage characteristics  
Ambient temperature: 25°C 77°F

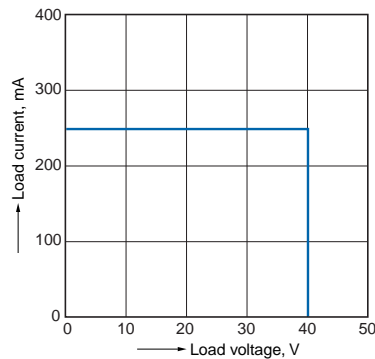

3. On resistance vs. ambient temperature characteristics

Measured portion: between terminals 3 and 4  
LED current: 5 mA; Load voltage: 10V (DC);  
Continuous load current: 250 mA (DC)

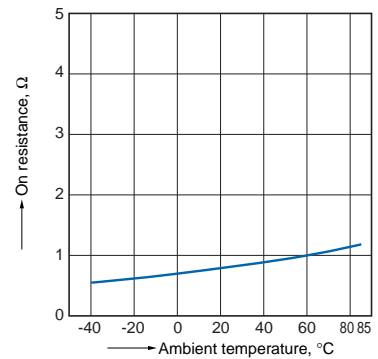

# RF VSSOP 1 Form A C×R10 (AQY221R2T)

## 4. Turn on time vs. ambient temperature characteristics

Measured portion: between terminals 3 and 4  
LED current: 5 mA; Load voltage: 10V (DC);  
Continuous load current: 250 mA (DC)

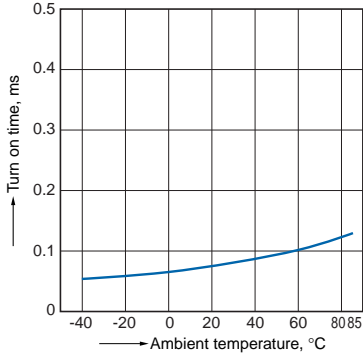

## 5. Turn off time vs. ambient temperature characteristics

Measured portion: between terminals 3 and 4  
LED current: 5 mA; Load voltage: 10V (DC);  
Continuous load current: 250 mA (DC)

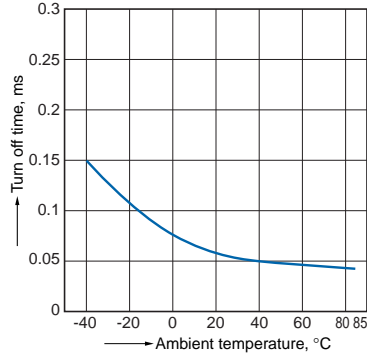

## 6. LED operate current vs. ambient temperature characteristics

Measured portion: between terminals 3 and 4  
Load voltage: 10V (DC);  
Continuous load current: 250 mA (DC)

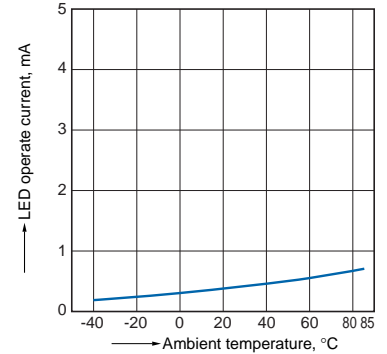

## 7. LED turn off current vs. ambient temperature characteristics

Measured portion: between terminals 3 and 4  
Load voltage: 10V (DC);  
Continuous load current: 250 mA (DC)

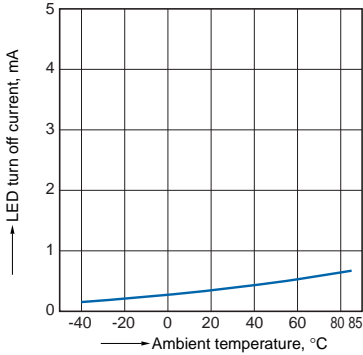

## 8. LED dropout voltage vs. ambient temperature characteristics

LED current: 5 to 50 mA

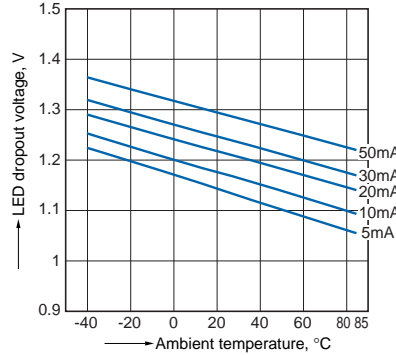

## 9. Current vs. voltage characteristics of output at MOS portion

Measured portion: between terminals 3 and 4  
Ambient temperature: 25°C 77°F

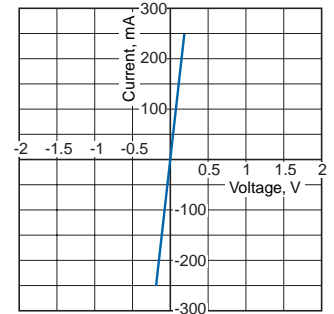

## 10. Off state leakage current vs. load voltage characteristics

Measured portion: between terminals 3 and 4  
Ambient temperature: 25°C 77°F

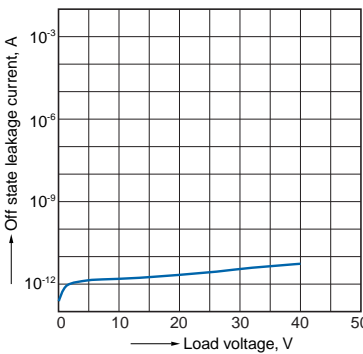

## 11. Turn on time vs. LED forward current characteristics

Measured portion: between terminals 3 and 4  
Load voltage: 10V (DC); Continuous load current: 250 mA (DC); Ambient temperature: 25°C 77°F

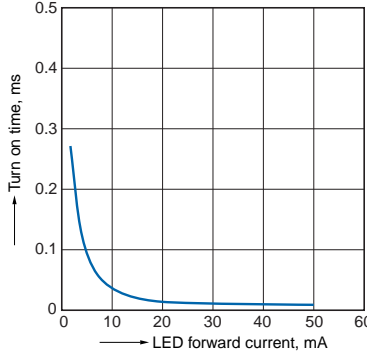

## 12. Turn off time vs. LED forward current characteristics

Measured portion: between terminals 3 and 4  
Load voltage: 10V (DC); Continuous load current: 250 mA (DC); Ambient temperature: 25°C 77°F

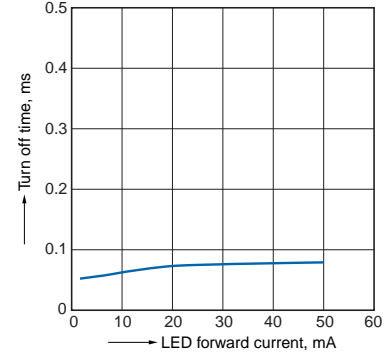

## 13. Output capacitance vs. applied voltage characteristics

Measured portion: between terminals 3 and 4  
Frequency: 1 MHz, 30m Vrms; Ambient temperature: 25°C 77°F

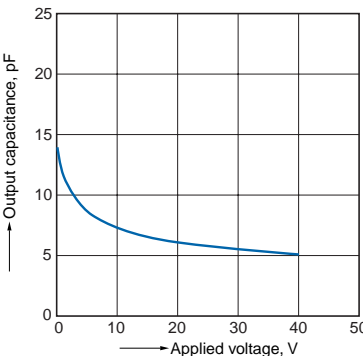

## 14. Isolation vs. frequency characteristics (50Ω impedance)

Measured portion: between terminals 3 and 4  
Ambient temperature: 25°C 77°F

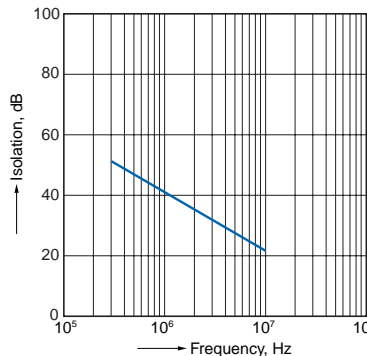

## 15. Insertion loss vs. frequency characteristics (50Ω impedance)

Measured portion: between terminals 3 and 4  
Ambient temperature: 25°C 77°F

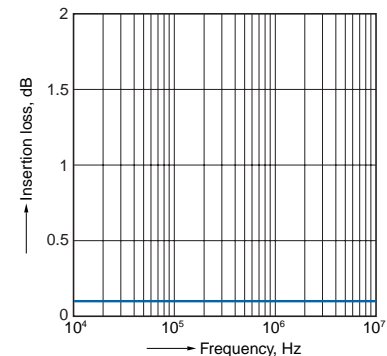

# RF VSSOP 1 Form A C×R10 (AQY221R2T)

## 16. On resistance distribution

Measured portion: between terminals 3 and 4  
 Continuous load current: 250 mA (DC), n: 50pcs.  
 Ambient temperature: 25°C 77°F

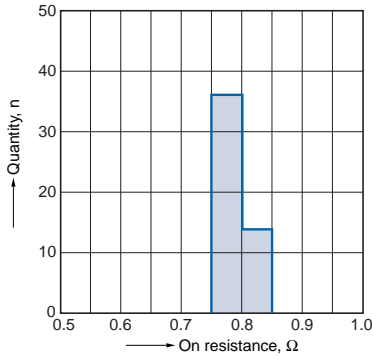

## 17. Turn on time distribution

Load voltage: 10V (DC)  
 Continuous load current: 250 mA (DC), n: 50pcs.  
 Ambient temperature: 25°C 77°F

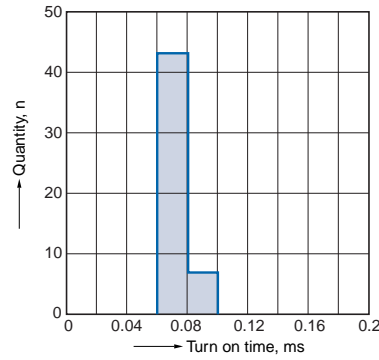

## 18. Turn off time distribution

Load voltage: 10V (DC)  
 Continuous load current: 250 mA (DC), n: 50pcs.  
 Ambient temperature: 25°C 77°F

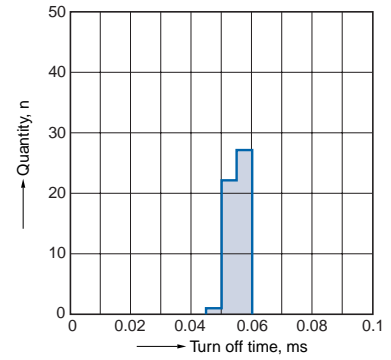

## 19. LED operate current distribution

Load voltage: 10V (DC)  
 Continuous load current: 250 mA (DC), n: 50pcs.  
 Ambient temperature: 25°C 77°F

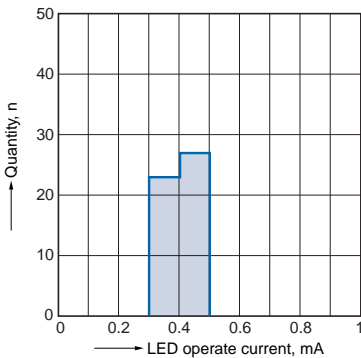

## DIMENSIONS (mm inch)

The CAD data of the products with a **CAD Data** mark can be downloaded from: <http://panasonic-electric-works.net/ac>

### CAD Data



### External dimensions

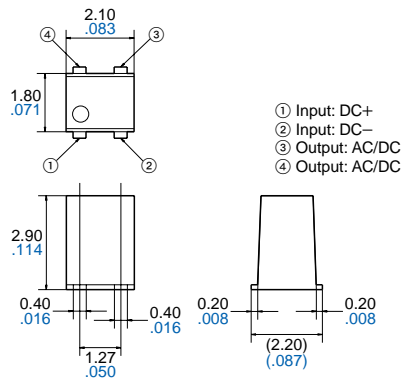

### Recommended mounting pad (Top view)

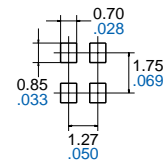

Tolerance:  $\pm 0.1 \pm .004$

General tolerance:  $\pm 0.1 \pm .004$

## SCHEMATIC AND WIRING DIAGRAMS

E<sub>1</sub>: Power source at input side, I<sub>F</sub>: LED forward current, V<sub>L</sub>: Load voltage, I<sub>L</sub>: Load current

Schematic	Output configuration	Load	Connection	Wiring diagram
	1 Form A	AC/DC	—	

## PhotoMOS CAUTIONS FOR USE SAFETY WARNINGS

• Do not use the product under conditions that exceed the range of its specifications. It may cause overheating, smoke, or fire.

• Do not touch the recharging unit while the power is on. There is a danger of electrical shock. Be sure to turn off the power when performing mounting, maintenance, or repair operations on the device (including connecting parts such as the terminal board and socket).

• Check the connection diagrams in the catalog and be sure to connect the terminals correctly. Erroneous connections could lead to unexpected operating errors, overheating, or fire.

### 1. Please refer to "PhotoMOS®" catalog (latest version) for cautions for use and explanations of terminology.

### 2. Derated designs

Consideration of reliability is absolutely imperative for derated designs because of its importance to the working lifetime of the product.

Please be sure to derate sufficiently from the maximum rating of the device when designing a system. Be sure to conduct real-life testing of the product; and, if necessary, provide extra leeway against the maximum rating by taking sufficiently safety measures.

### 3. Applying stress that exceeds the absolute maximum rating

If the voltage or current value for any of the terminals exceeds the absolute maximum rating, internal elements will deteriorate because of the excessive voltage or current. In extreme cases, wiring may melt, or silicon P/N junctions may be destroyed.

Therefore, the circuit should be designed in such a way that the load never exceed the absolute maximum ratings, even momentarily.

### 4. Deterioration and destruction caused by discharge of static electricity

This phenomenon is generally called static electricity destruction, and occurs when static electricity generated by various factors is discharged while the device terminals are in contact, producing internal destruction of the element.

To prevent problems from static electricity, the following precautions and measures should be taken when using your device.

1) Employees handling devices should wear anti-static clothing and should be grounded through protective resistance of 500 kΩ to 1 MΩ.

2) A conductive metal sheet should be placed over the work table. Measuring instruments and jigs should be grounded.

3) When using soldering irons, either use irons with low leakage current, or ground the tip of the soldering iron. (Use of low-voltage soldering irons is also recommended.)

4) Devices and equipment used in assembly should also be grounded.

5) When packing printed circuit boards and equipment, avoid using high-polymer materials such as foam styrene, plastic, and other materials which carry an electrostatic charge.

6) When storing or transporting devices, the environment should not be conducive to generating static electricity (for instance, the humidity should be between 45 and 60%), and devices should be protected using conductive packing materials.

### 5. Short across terminals

Do not short circuit between terminals when device is energized, since there is possibility of breaking of the internal IC.

### 6. Output spike voltages

1) If an inductive load generates spike voltages which exceed the absolute maximum rating, the spike voltage must be limited. Typical circuits are shown below.

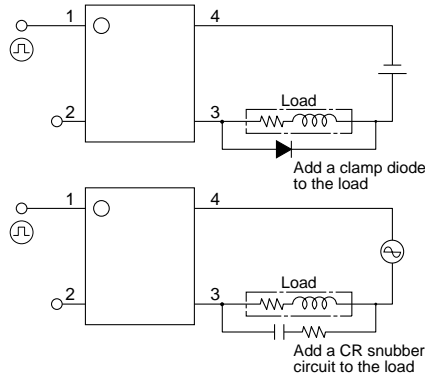

2) Even if spike voltages generated at the load are limited with a clamp diode if the circuit wires are long, spike voltages will occur by inductance. Keep wires as short as possible to minimize inductance.

### 7. Ripple in the input power supply

If ripple is present in the input power supply, observe the following:

- 1) For LED operate current at  $E_{min}$ , maintain the value mentioned in the table of "Recommended LED forward current ( $I_F$ )."
- 2) Keep the LED operate current at 50 mA or less at  $E_{max}$ .

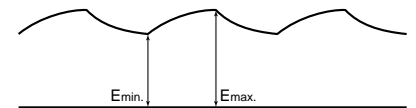

### 8. Soldering

• Example of recommended soldering conditions

(1) IR (Infrared reflow) soldering method

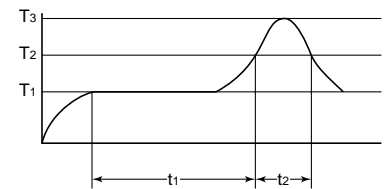

$T_1 = 150$  to  $180^\circ\text{C}$   $302$  to  $356^\circ\text{F}$   
 $T_2 = 230^\circ\text{C}$   $446^\circ\text{F}$   
 $T_3 = 245^\circ\text{C}$   $473^\circ\text{F}$  or less  
 $t_1 = 60$  to  $120$  s or less  
 $t_2 = 30$  s or less

(2) Soldering iron method

Tip temperature:  $350$  to  $400^\circ\text{C}$   $662$  to  $752^\circ\text{F}$

Wattage:  $30$  to  $60$  W

Soldering time: within  $3$  s

(3) Others

Check mounting conditions before using other soldering methods (VPS, hot-air, hot plate, laser, pulse heater, etc.)

# RF VSSOP 1 Form A C×R10 (AQY221R2T)

## 9. Notes for mounting

- 1) If many different packages are combined on a single substrate, then lead temperature rise is highly dependent on package size. For this reason, please make sure that the temperature of the terminal solder area of the PhotoMOS falls within the temperature conditions of item "8. Soldering" before mounting.
- 2) If the mounting conditions exceed the recommended solder conditions in item 8, resin strength will fall and the nonconformity of the heat expansion coefficient of each constituent material will increase markedly, possibly causing cracks in the package, severed bonding wires, and the like. For this reason, please inquire with us about whether this use is possible.

## 10. Cleaning

This product creates a light path by coupling with resin the LED of the emitting element and the solar cell of the receiving element. For this reason, ultrasonic cleaning should be avoided as much as possible, because the product differs from other molded resin products that contain discrete elements (MOS transistors and bipolar transistors, etc.). We recommend cleaning with an organic solvent. If you cannot avoid using ultrasonic cleansing, please ensure that the following conditions are met, and check beforehand for defects.

- Frequency: 27 to 29 kHz
- Ultrasonic output: No greater than 0.25W/cm<sup>2</sup>
- Cleaning time: No longer than 30 s

- Cleanser used: Asahiklin AK-225
- Other: Submerge in solvent in order to prevent the PCB and elements from being contacted directly by the ultrasonic vibrations.

Note: Applies to unit area ultrasonic output for ultrasonic baths.

## 11. Device packaging format

Tape and reel (Unit: mm *inch*)

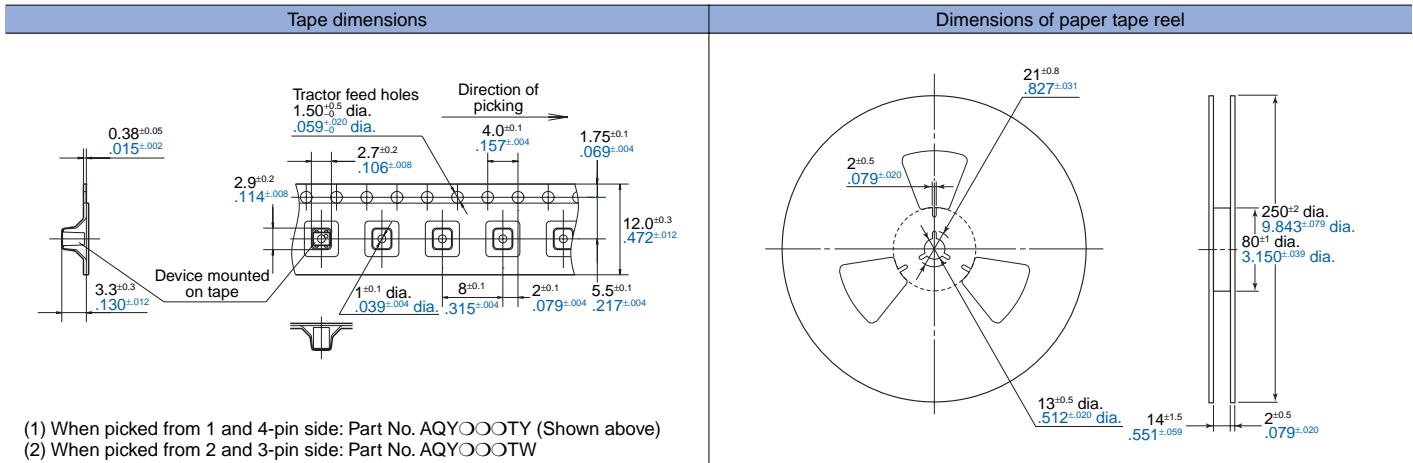

## 12. Transportation and storage

- 1) Extreme vibration during transport will damage the device. Handle the outer and inner boxes with care.
- 2) Storage under extreme conditions will cause soldering degradation, external appearance defects, and deterioration of the characteristics. The following storage conditions are recommended:
  - Temperature: 0 to 45°C 32 to 113°F
  - Humidity: Less than 70% R.H.
  - Atmosphere: No harmful gasses such as sulfurous acid gas, minimal dust.
- 3) PhotoMOS implemented in VSSOP type are sensitive to moisture and come in sealed moisture-proof packages. Observe the following cautions on storage.
  - After the moisture-proof package is unsealed, take the devices out of storage as soon as possible (within 1 month, less than 45°C 113°F/70% R.H.).
  - If the devices are to be left in storage for a considerable period after the moisture-proof package has been unsealed, it is recommended to keep them in another

moisture-proof bag containing silica gel (within 3 months at the most).

\*When thermal stress is applied when mounting with solder after the product has absorbed moisture, the water will evaporate, swelling will occur, and the inside of the package will become stressed. Since this can lead to bulging and cracking of the package surface, please be sure to be careful and follow the correct soldering conditions.

## 13. About the exposed terminals on the sides of the package

As shown in the following figure, part of the input and output frames are exposed on the sides of the package. Due to this, please be keep in mind the cautions listed below.

- 1) Shorting the exposed terminals may cause deterioration of the insulation between the inputs and outputs, and may damage the internal IC.
- 2) Since the exposed terminals are connected electrically to the internal element, please refer to the section "4. Deterioration and destruction caused by

discharge of static electricity", and implement sufficient measures to control static electricity.

- 3) When installing the devices in the vicinity, please keep in mind that if the exposed frames of adjacent devices get too close, a short between devices may occur.

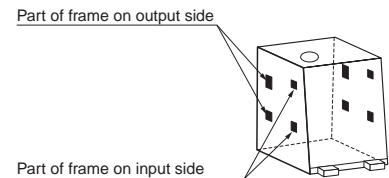

## 14. Regarding close installations

When this product is installed close to other parts, the ambient temperature may rise due to heating of the internal element when power is applied. Be sure to use with a reduced load current after testing under actual conditions, because the degree of temperature rise depends on the placement of the devices and conditions of use.

# Mouser Electronics

Authorized Distributor

Click to View Pricing, Inventory, Delivery & Lifecycle Information:

Panasonic:

[AQY221R2TW](#) [AQY221R2TY](#)