



Parameter	Rating	Units
AC Operating Voltage	20 - 240	V_{rms}
Continuous Load Current	3	A_{rms}
On-State Voltage Drop	1.1	V_P (at $I_L = 2A_P$)
Blocking Voltage	800	V_P
Turn-On Delay ($I_F=15mA$)	20	μs

Features

- Load Current up to $3A_{rms}$
- 800V_P Blocking Voltage
- Rapid Turn-On (Non-Zero-Cross Turn-On)
- 5mA Sensitivity
- Creepage Distance: 5.7 mm (0.224 inches)
- DC Control, AC Output
- Optically Isolated
- Low EMI and RFI Generation
- High Noise Immunity
- Flammability Rating UL 94 V-0

Applications

- Lighting
- HVAC (Heating, Ventilation, Air Conditioning)
- Programmable Control
- Process Control
- Power Control Panels
- Remote Switching
- Gas Pump Electronics
- Contactors
- Large Relays
- Solenoids
- Motors
- Heaters

Description

CPC1966BX8 is an AC Solid State Switch utilizing dual power SCR outputs. This device features Rapid Turn-On (non-zero-cross) control of the output SCRs, which makes it ideal for precisely switching AC loads independent of the load voltage phase.

The optically coupled input and output circuits provide 3750V_{rms} of isolation and noise immunity between the control and load circuits. As a result, the CPC1966BX8 is well suited for industrial environments where electromagnetic interference would disrupt the operation of plant facility communication and control systems.

Approvals

- UL Recognized Component: File E69938
- CSA Certified Component: Certificate 1172007

Ordering Information

Part #	Description
CPC1966BX8	8-Pin Power SOIC (25/Tube)

Pin Configuration

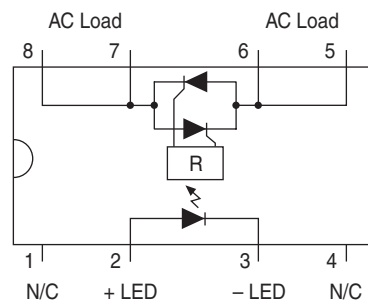

Rapid Turn-On (Non-Zero-Cross) Waveforms

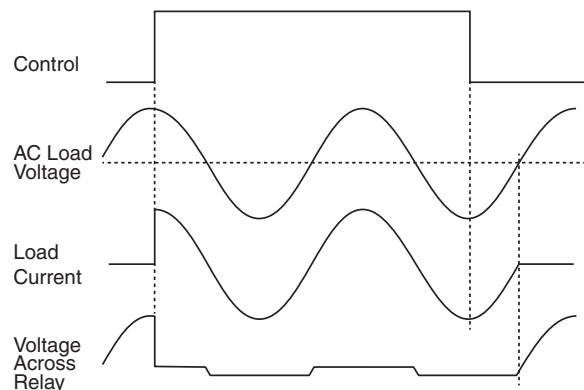

Absolute Maximum Ratings @ 25°C

Parameter	Symbol	Ratings	Units
Blocking Voltage	V_{DRM}	800	V_P
Reverse Input Voltage		5	V
Input Control Current	I_F	50	mA
Peak (10ms)		1	A
Input Power Dissipation ¹	-	150	mW
Total Power Dissipation ²	P_D	2400	mW
i^2t Fusing Current (1/2 Sine Wave, 60Hz)	-	8	A^2s
ESD, Human Body Model	-	4	kV
Isolation Voltage, Input to Output	V_{IO}	3750	V_{rms}
Operational Temperature	T_A	-40 to +85	°C
Storage Temperature	T_A	-40 to +125	°C

Absolute Maximum Ratings are stress ratings. Stresses in excess of these ratings can cause permanent damage to the device. Functional operation of the device at conditions beyond those indicated in the operational sections of this data sheet is not implied.

Typical values are characteristic of the device at +25°C, and are the result of engineering evaluations. They are provided for information purposes only, and are not part of the manufacturing testing requirements.

¹ Derate linearly 1.33 mW / °C

² Derate linearly 20 mW / °C

Electrical Characteristics @ 25°C

Parameters	Conditions	Symbol	Min	Typ	Max	Units
Output Characteristics						
Load Current, Continuous	$V_L=20-240V_{rms}$	I_L	0.1	-	3	A_{rms}
Maximum Surge Current	$t \leq 16ms$	I_P	-	-	30	A
Off State Leakage Current	V_{DRM}	I_{LEAK}	-	-	100	μA_P
On-State Voltage Drop	$I_L=2A_P$	-	-	0.88	1.1	V_P
Critical Rate of Rise of On-State Current	-	di/dt	-	-	75	A/ μs
Off-State dV/dt	-	dV/dt	1000	-	-	V/ μs
Switching Speeds	$I_F = 5mA$, Resistive, $V_L=20V$	t_{on}	-	45	-	μs
Turn-on			-	-	20	
Turn-off		$I_F = 15mA$, Resistive, $V_L=20V$	t_{off}	-	-	0.5
Holding Current	-	I_H	-	44	50	mA
Latching Current	-	I_L	-	48	75	mA
Operating Frequency	-		20	-	500	Hz
Input Characteristics						
Input Control Current to Activate ¹	-	I_F	-	-	5	mA
Input Drop-out Voltage	-	-	0.8	-	-	V
Input Voltage Drop	$I_F=5mA$	V_F	0.9	1.2	1.4	V
Reverse Input Current	$V_R=5V$	I_R	-	-	10	μA
Common Characteristics						
Input to Output Capacitance	$V_{IO}=0V$, $f=1MHz$	C_{IO}	-	1	-	pF

¹ For high-noise environments, or for high-frequency operation, use $I_F \geq 10mA$.

PERFORMANCE DATA @25°C (Unless Otherwise Noted)*

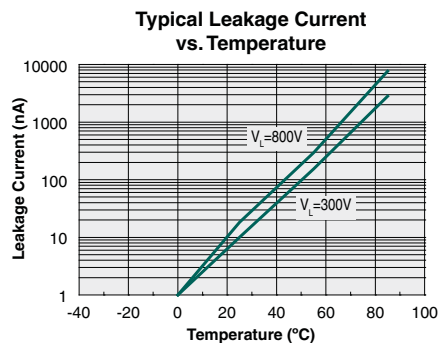
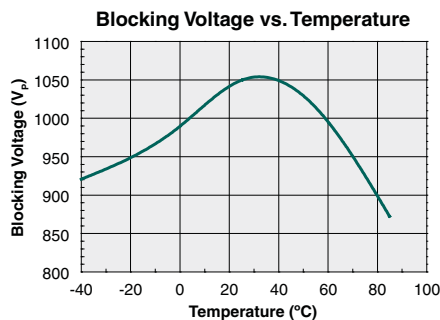
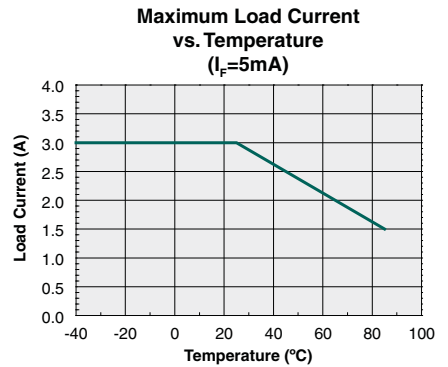
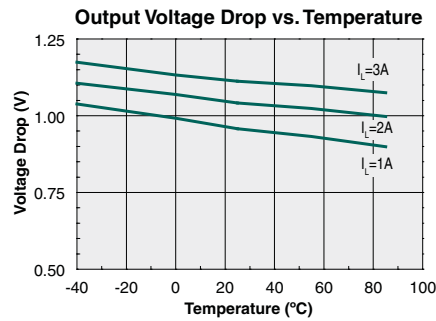
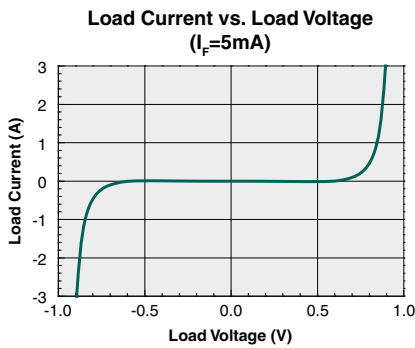
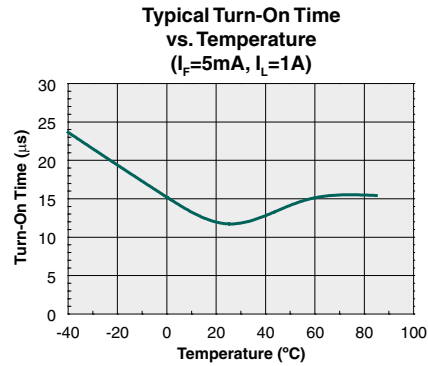
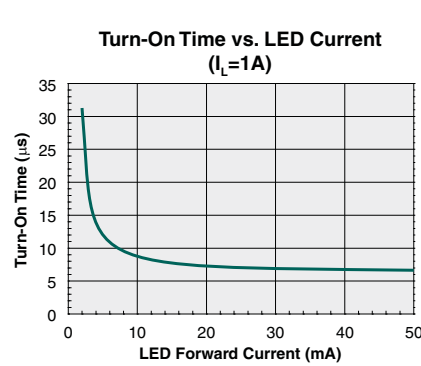
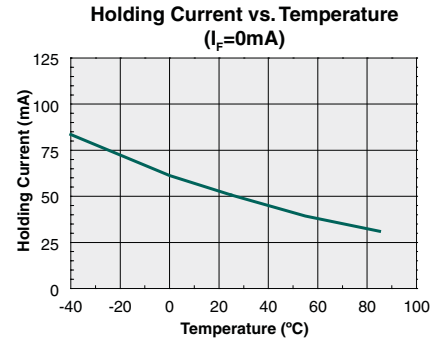
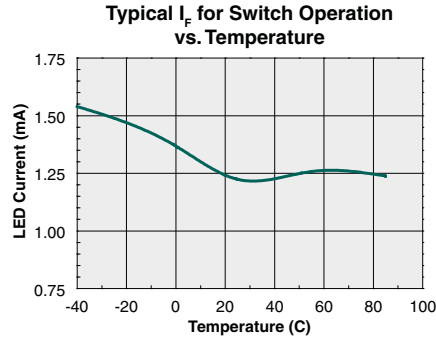
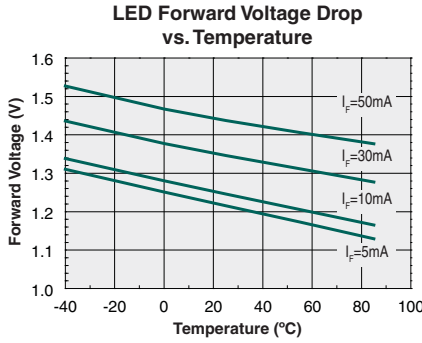

* The Performance data shown in the graphs above is typical of device performance. For guaranteed parameters not indicated in the written specifications, please contact our application department.

Manufacturing Information

Moisture Sensitivity



All plastic encapsulated semiconductor packages are susceptible to moisture ingress. IXYS Integrated Circuits Division classifies its plastic encapsulated devices for moisture sensitivity according to the latest version of the joint industry standard, **IPC/JEDEC J-STD-020**, in force at the time of product evaluation. We test all of our products to the maximum conditions set forth in the standard, and guarantee proper operation of our devices when handled according to the limitations and information in that standard as well as to any limitations set forth in the information or standards referenced below.

Failure to adhere to the warnings or limitations as established by the listed specifications could result in reduced product performance, reduction of operable life, and/or reduction of overall reliability.

This product carries a Moisture Sensitivity Level (MSL) classification as shown below, and should be handled according to the requirements of the latest version of the joint industry standard **IPC/JEDEC J-STD-033**.

Device	Moisture Sensitivity Level (MSL) Classification
CPC1966BX8	MSL 1

ESD Sensitivity



This product is **ESD Sensitive**, and should be handled according to the industry standard **JESD-625**.

Soldering Profile

Provided in the table below is the Classification Temperature (T_C) of this product and the maximum dwell time the body temperature of this device may be ($T_C - 5$)°C or greater. The classification temperature sets the Maximum Body Temperature allowed for this device during lead-free reflow processes. For through-hole devices, and any other processes, the guidelines of **J-STD-020** must be observed.

Device	Classification Temperature (T_C)	Dwell Time (t_p)	Max Reflow Cycles
CPC1966BX8	245°C	30 seconds	3

Board Wash

IXYS Integrated Circuits Division recommends the use of no-clean flux formulations. Board washing to reduce or remove flux residue following the solder reflow process is acceptable provided proper precautions are taken to prevent damage to the device. These precautions include, but are not limited to: using a low pressure wash and providing a follow up bake cycle sufficient to remove any moisture trapped within the device due to the washing process. Due to the variability of the wash parameters used to clean the board, determination of the bake temperature and duration necessary to remove the moisture trapped within the package is the responsibility of the user (assembler). Cleaning or drying methods that employ ultrasonic energy may damage the device and should not be used. Additionally, the device must not be exposed to flux or solvents that are Chlorine- or Fluorine-based.



MECHANICAL DIMENSIONS

CPC1966BX8

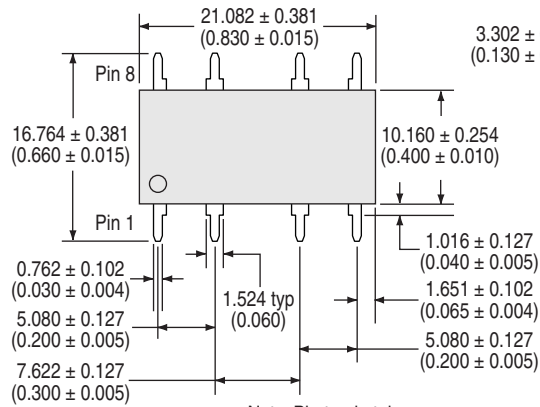

Note: Pin-to-pin tolerances are non-cumulative.

Dimensions
Unless Otherwise Noted
mm
(inches)

Recommended PCB Pattern

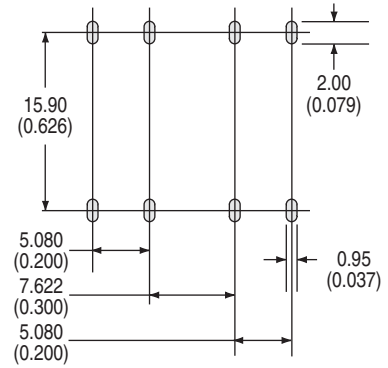

For additional information please visit our website at: www.ixysic.com

IXYS Integrated Circuits Division makes no representations or warranties with respect to the accuracy or completeness of the contents of this publication and reserves the right to make changes to specifications and product descriptions at any time without notice. Neither circuit patent licenses nor indemnity are expressed or implied. Except as set forth in IXYS Integrated Circuits Division's Standard Terms and Conditions of Sale, IXYS Integrated Circuits Division assumes no liability whatsoever, and disclaims any express or implied warranty, relating to its products including, but not limited to, the implied warranty of merchantability, fitness for a particular purpose, or infringement of any intellectual property right.

The products described in this document are not designed, intended, authorized or warranted for use as components in systems intended for surgical implant into the body, or in other applications intended to support or sustain life, or where malfunction of IXYS Integrated Circuits Division's product may result in direct physical harm, injury, or death to a person or severe property or environmental damage. IXYS Integrated Circuits Division reserves the right to discontinue or make changes to its products at any time without notice.

Mouser Electronics

Authorized Distributor

Click to View Pricing, Inventory, Delivery & Lifecycle Information:

[IXYS:](#)

[CPC1966BX8](#)