



Parameters	Ratings	Units
Peak Blocking Voltage	350	V_P
Load Current	120	mA_{rms} / mA_{DC}
On-Resistance (max)	30	Ω

Features

- 5000V_{rms} Input/Output Isolation
- 350V_P Blocking Voltage
- 100% Solid State
- Low Drive Power Requirements (TTL/CMOS Compatible)
- Arc-Free With No Snubbing Circuits
- No EMI/RFI Generation
- Small 4-Pin Package
- Machine Insertable, Wave Solderable

Applications

- Instrumentation
 - Multiplexers
 - Data Acquisition
 - Electronic Switching
 - I/O Subsystems
- Meters (Watt-Hour, Water, Gas)
- Medical Equipment—Patient/Equipment Isolation
- Security
- Aerospace
- Industrial Controls

Description

The CPC1330G is a single-pole normally-open (1-Form-A) Solid State Relay with an enhanced input to output isolation barrier of 5000V_{rms}.

The relay output is constructed with efficient MOSFET switches that use IXYS Integrated Circuits Division's patented OptoMOS architecture. The input, a highly efficient GaAlAs infrared LED, controls the optically coupled output.

Approvals

- UL Certified Component: File E76270
- CSA Certified Component: Certificate 1172007
- EN/IEC 60950-1 Certified Component:
TUV Certificate B 10 05 49410 006

Ordering Information

Part Number	Description
CPC1330G	4-Pin DIP (100/Tube)
CPC1330GR	4-Pin Surface Mount (100/Tube)
CPC1330GRTR	4-Pin Surface Mount (1000/Reel)

Pin Configuration

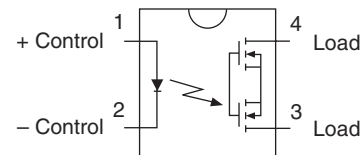

Switching Characteristics of Normally Open Devices

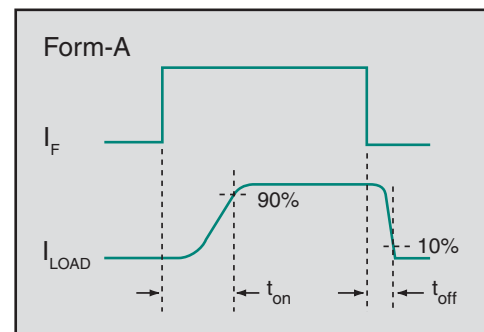

Absolute Maximum Ratings @ 25°C

Parameter	Ratings	Units
Peak Blocking Voltage	350	V _P
Reverse Input Voltage	5	V
Input Control Current	50	mA
Peak (10ms)	1	A
Input Power Dissipation ¹	100	mW
Total Package Dissipation ²	550	mW
Isolation Voltage, Input to Output	5000	V _{rms}
Operational Temperature	-40 to +85	°C
Storage Temperature	-40 to +125	°C

¹ Derate linearly 1.33 mW / °C

² Derate linearly 3.00 mW / °C

Absolute Maximum Ratings are stress ratings. Stresses in excess of these ratings can cause permanent damage to the device. Functional operation of the device at conditions beyond those indicated in the operational sections of this data sheet is not implied.

Electrical Characteristics @ 25°C

Parameters	Conditions	Symbol	Min	Typ	Max	Units
Output Characteristics						
Load Current						
Continuous	-	I _L	-	-	120	mA _{rms} / mA _{DC}
Peak	t=10ms	I _{LPK}	-	-	±350	mA _P
On-Resistance	I _L =120mA	R _{ON}	-	25	30	Ω
Off-State Leakage Current	V _L =350V _P	I _{LEAK}	-	-	1	μA
Switching Speeds						
Turn-On	I _F =5mA, V _L =10V	t _{on}	-	-	2	ms
Turn-Off		t _{off}	-	-	1	
Output Capacitance	I _F =0mA, V _L =50V, f=1MHz	C _{OUT}	-	25	-	pF
Input Characteristics						
Input Control Current to Activate	I _L =120mA	I _F	-	0.33	2	mA
Input Control Current to Deactivate	-	I _F	0.2	0.3	-	mA
Input Voltage Drop	I _F =5mA	V _F	0.9	1.2	1.4	V
Reverse Input Current	V _R =5V	I _R	-	-	10	μA
Common Characteristics						
Input to Output Capacitance	-	C _{I/O}	-	3	-	pF

PERFORMANCE DATA*

Typical LED Forward Voltage Drop
(N=50, $I_F=5\text{mA}$, $T_A=25^\circ\text{C}$)

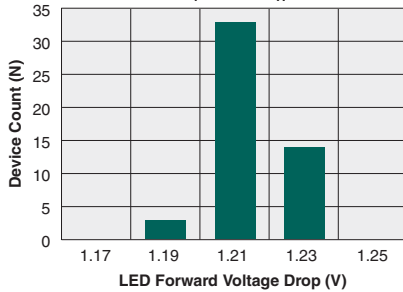

Typical Turn-On Time
(N=50, $I_F=5\text{mA}$, $I_L=120\text{mA}$, $T_A=25^\circ\text{C}$)

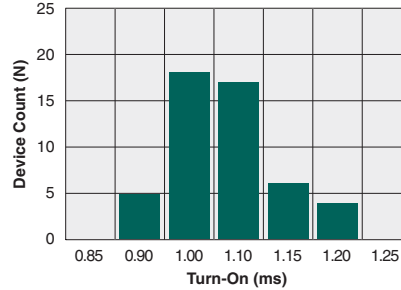

Typical Turn-Off Time
(N=50, $I_F=5\text{mA}$, $I_L=120\text{mA}$, $T_A=25^\circ\text{C}$)

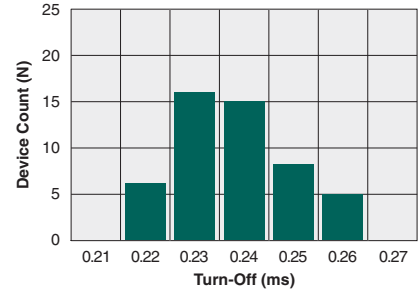

Typical I_F for Switch Operation
(N=50, $I_L=120\text{mA}$, $T_A=25^\circ\text{C}$)

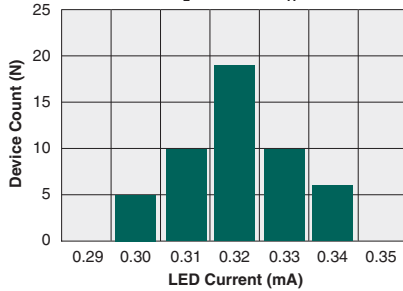

Typical I_F for Switch Dropout
(N=50, $I_L=120\text{mA}$, $T_A=25^\circ\text{C}$)

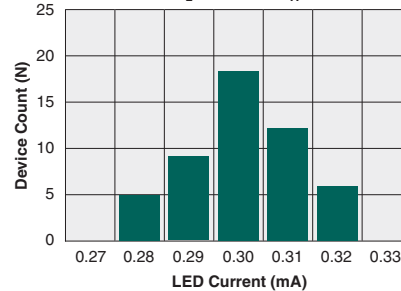

Typical On-Resistance Distribution
(N=50, $I_L=120\text{mA}$, $T_A=25^\circ\text{C}$)

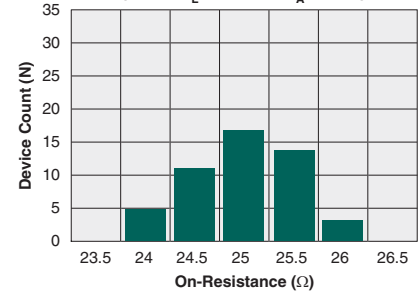

Typical Blocking Voltage Distribution
(N=50, $T_A=25^\circ\text{C}$)

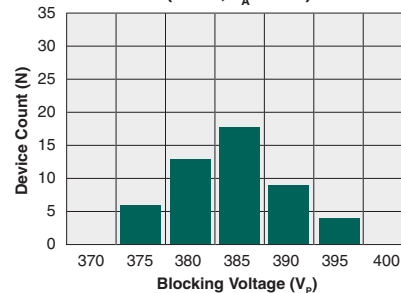

Typical LED Forward Voltage Drop vs. Temperature

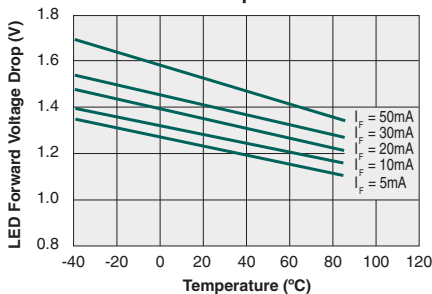

Typical Turn-On vs. LED Forward Current
($I_L=120\text{mA}$)

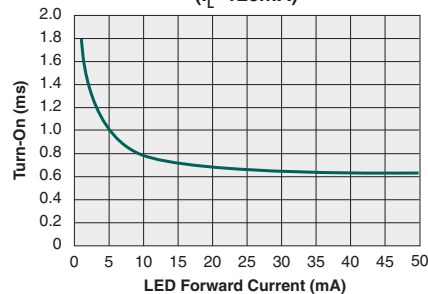

Typical Turn-Off vs. LED Forward Current
($I_L=120\text{mA}$)

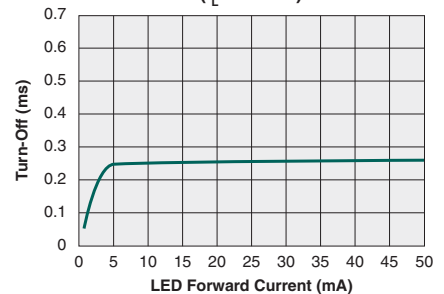

*The Performance data shown in the graphs above is typical of device performance. For guaranteed parameters not indicated in the written specifications, please contact our application department.

PERFORMANCE DATA*

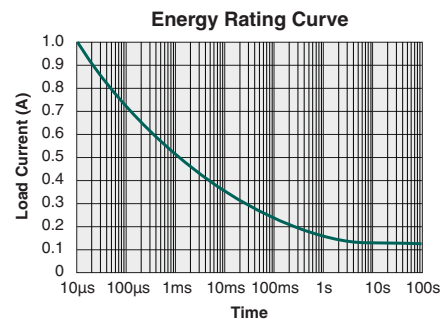
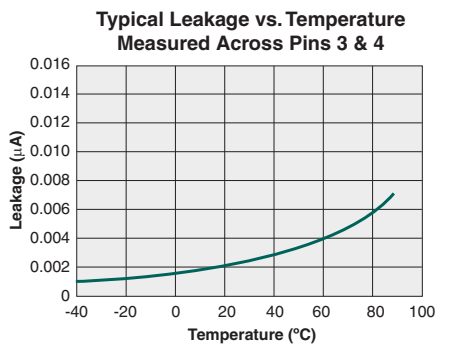
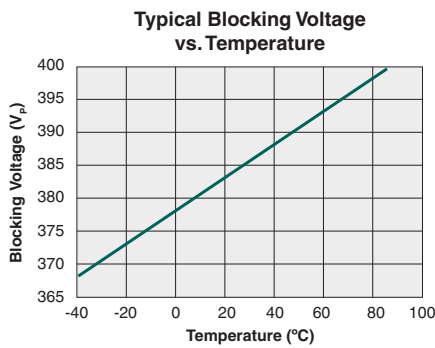
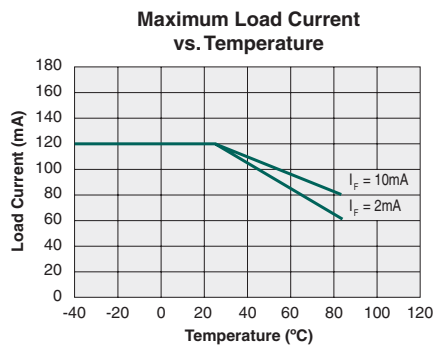
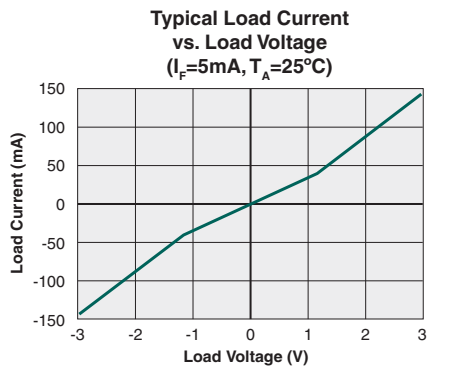
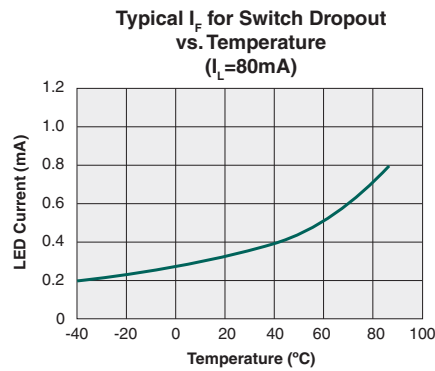
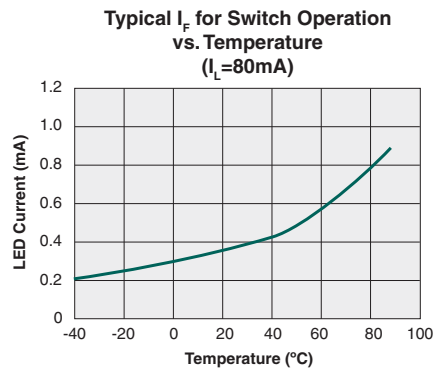
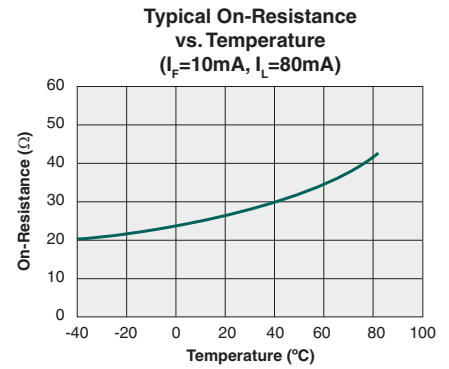
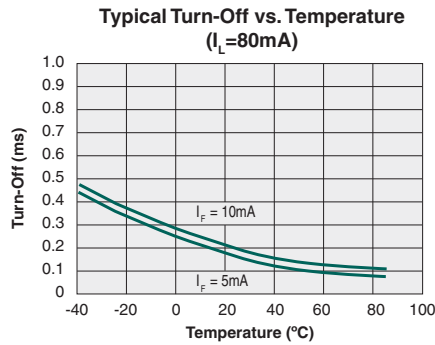
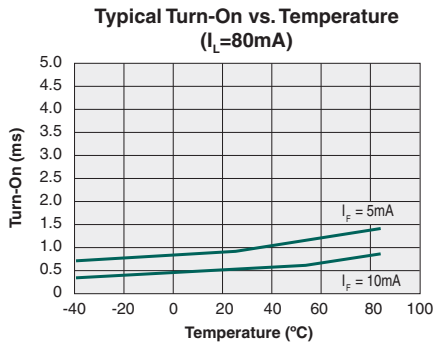

*The Performance data shown in the graphs above is typical of device performance. For guaranteed parameters not indicated in the written specifications, please contact our application department.

Manufacturing Information

Moisture Sensitivity



All plastic encapsulated semiconductor packages are susceptible to moisture ingress. IXYS Integrated Circuits Division classified all of its plastic encapsulated devices for moisture sensitivity according to the latest version of the joint industry standard, **IPC/JEDEC J-STD-020**, in force at the time of product evaluation. We test all of our products to the maximum conditions set forth in the standard, and guarantee proper operation of our devices when handled according to the limitations and information in that standard as well as to any limitations set forth in the information or standards referenced below.

Failure to adhere to the warnings or limitations as established by the listed specifications could result in reduced product performance, reduction of operable life, and/or reduction of overall reliability.

This product carries a **Moisture Sensitivity Level (MSL) rating** as shown below, and should be handled according to the requirements of the latest version of the joint industry standard **IPC/JEDEC J-STD-033**.

Device	Moisture Sensitivity Level (MSL) Rating
CPC1330G / CPC1330GR	MSL 1

ESD Sensitivity



This product is **ESD Sensitive**, and should be handled according to the industry standard **JESD-625**.

Reflow Profile

This product has a maximum body temperature and time rating as shown below. All other guidelines of **J-STD-020** must be observed.

Device	Maximum Temperature x Time
CPC1330G / CPC1330GR	250°C for 30 seconds

Board Wash

IXYS Integrated Circuits Division recommends the use of no-clean flux formulations. However, board washing to remove flux residue is acceptable. Since IXYS Integrated Circuits Division employs the use of silicone coating as an optical waveguide in many of its optically isolated products, the use of a short drying bake could be necessary if a wash is used after solder reflow processes. Chlorine- or Fluorine-based solvents or fluxes should not be used. Cleaning methods that employ ultrasonic energy should not be used.



MECHANICAL DIMENSIONS

CPC1330G

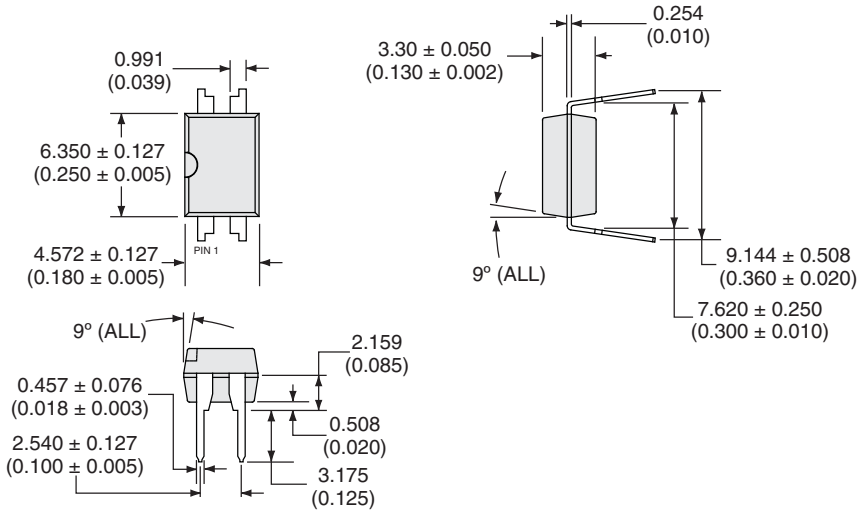

PC Board Pattern (Top View)

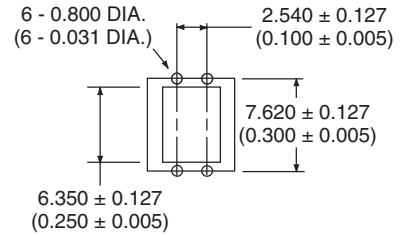

Dimensions
mm
(inches)

CPC1330GR

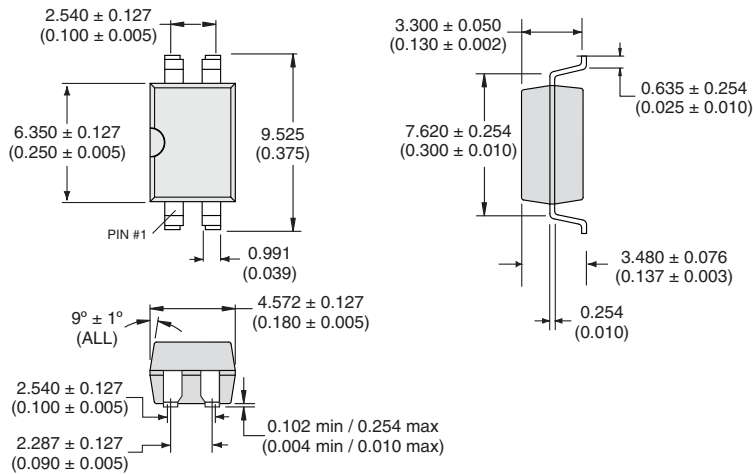

PCB Land Pattern

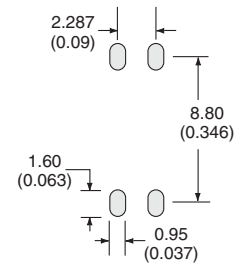

Dimensions
mm
(inches)

CPC1330GRTR Tape & Reel

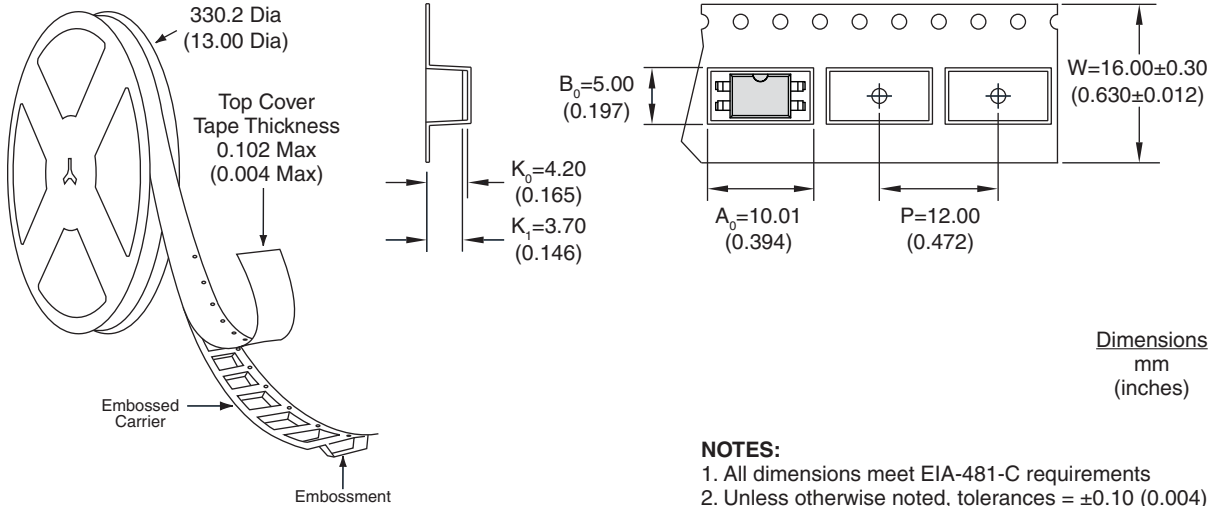

NOTES:

1. All dimensions meet EIA-481-C requirements
2. Unless otherwise noted, tolerances = ± 0.10 (0.004)

For additional information please visit our website at: www.ixysic.com

IXYS Integrated Circuits Division makes no representations or warranties with respect to the accuracy or completeness of the contents of this publication and reserves the right to make changes to specifications and product descriptions at any time without notice. Neither circuit patent licenses nor indemnity are expressed or implied. Except as set forth in IXYS Integrated Circuits Division's Standard Terms and Conditions of Sale, IXYS Integrated Circuits Division assumes no liability whatsoever, and disclaims any express or implied warranty, relating to its products including, but not limited to, the implied warranty of merchantability, fitness for a particular purpose, or infringement of any intellectual property right.

The products described in this document are not designed, intended, authorized or warranted for use as components in systems intended for surgical implant into the body, or in other applications intended to support or sustain life, or where malfunction of IXYS Integrated Circuits Division's product may result in direct physical harm, injury, or death to a person or severe property or environmental damage. IXYS Integrated Circuits Division reserves the right to discontinue or make changes to its products at any time without notice.

Mouser Electronics

Authorized Distributor

Click to View Pricing, Inventory, Delivery & Lifecycle Information:

[IXYS:](#)

[CPC1330G](#) [CPC1330GR](#) [CPC1330GRTR](#)